



Updated! Based on  
the 2018 Edition of the IBC

REV.  
6/19

# Fire Door Systems

## A Guide to Code Compliance

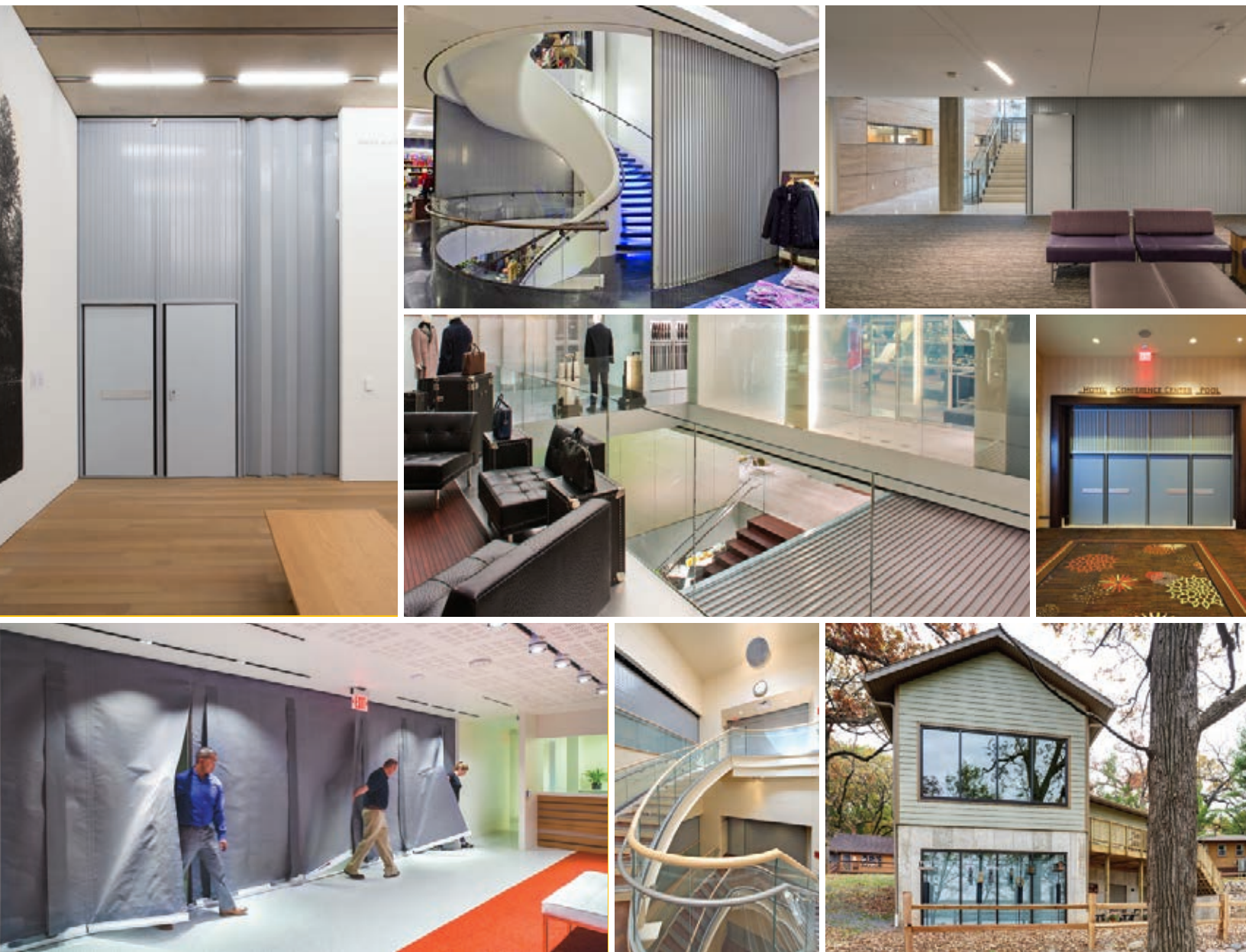

The logo features a solid yellow square at the top. Below it, the word "McKEON" is written in a bold, yellow, sans-serif font. Underneath the text are two horizontal yellow bars of equal length, stacked vertically.

**McKEON®**

# Fire Door Systems

A Guide to Code Compliance



44 Sawgrass Drive • Bellport, NY 11713

PH: 800-266-9392 • FAX: 631-803-3030

info@mckeondoor.com • www.mckeondoor.com

# CONTENTS

---

## APPLICATIONS

---

### 1 ELEVATOR SEPARATION

Elevator Lobbies & Hoistway Protection . . . . .	2
Elevator Smoke & Draft . . . . .	10

### 2 EXIT ACCESS SEPARATION

Horizontal Exit . . . . .	20
Exit Passageways . . . . .	24
Pedestrian Walkways & Tunnels . . . . .	27

### 3 VERTICAL OPENING SEPARATION

Fundamental Guidelines . . . . .	32
Draft Curtains, a Fire Protection Feature . . . . .	33
Exit Access Stairways . . . . .	37
Vertical Openings – Escalator . . . . .	43
Interior Exit Stairways . . . . .	47
Atriums . . . . .	52
Vertical Compartmentation . . . . .	57

### 4 OCCUPANCY SEPARATION

Fundamental Guidelines . . . . .	64
Mixed Occupancy – Accessory Use . . . . .	66
Mixed Occupancy Use – Non-Separated vs. Separated . . . . .	70

### 5 AREA SEPARATION

Allowable Area . . . . .	78
--------------------------	----

- 6 CORRIDOR SEPARATION**
  - Corridor Separation – Healthcare ..... 84
- 7 SMOKE COMPARTMENTATION**
  - Smoke Compartments – Healthcare ..... 96
  - Smoke Barriers – Healthcare .....101
- 8 RESILIENT CONSTRUCTION**
  - Storm Shelters ..... 106

**APPENDIX**

**DEFINITIONS**

- Fire Walls – Section 706 .....114
- Fire Barriers – Section 707 .....115
- Fire Partitions – Section 708 .....116
- Smoke Barriers – Section 709 .....117
- Smoke Partitions – Section 710 .....118

**RESOURCES**

- IBC 2018 Means of Egress .....119
- NFPA 101 Life Safety Code, 2018 ..... 120
- INTERTEK Code Compliance Research Report ..... 120
- IBC 2021 Code Change.....121
- Curtain Systems Egress Feature ..... 122

**12th Edition - June 2019** (updated April 2023)

Copyright © 2023 by McKeon Rolling Steel Door Co., Inc. All rights reserved. No part of this book may be reproduced, stored in a retrieval system, or transmitted, in any form or by any means, electronic, mechanical, photocopying, recording, or otherwise, without the prior written permission of the publisher. For more information contact [info@mckeondoor.com](mailto:info@mckeondoor.com).

## Introduction

**THIS EDITION of *Fire Door Systems, A Guide to Code Compliance* is based on the 2018 IBC with inserts from the “Group A” portion of the 2021 IBC code development cycle. The insertions reflect code changes that have been approved by the voting membership in both the general sessions and the subsequent on-line voting forum, and will be published in the next printing of the IBC.**

THE INTERNATIONAL BUILDING CODE has been widely accepted in the United States and is recognized as a uniform code addressing the design and installation of building systems with performance-based requirements. The current International Building Code has been developed over the last two decades through the extensive work and efforts of code enforcement personnel organized at both local and national levels under the direction of the International Code Council. A vital part of the development of the building code is the involvement of industry and nationally recognized organizations with interests in building product development and the protection of public health, safety and welfare.

McKEON develops and manufactures numerous fire and smoke rated assemblies that function as wide-span opening protectives. These building products enter the marketplace specifically to assist design professionals and code enforcement personnel in satisfying open design without compromising fire and life safety requirements. This document is formatted to present the building code as it pertains to the use of opening protectives; first, recite specific prescriptive code requirements, second, performance-based language in laymen’s terms for common sense understanding, and third, illustrate product case studies presented as design solutions to frequently approached complex code application challenges. The building code interpretations found herein represent the opinion and experience of the preparer, intended only to assist the reader in recognizing and understanding the potential use and application of McKEON fire and smoke rated opening protective assembly products.



The logo for McKEON features a large yellow square at the top. Below it, the word "McKEON" is written in a bold, yellow, sans-serif font, with a registered trademark symbol (®) to its upper right. Underneath the text are two horizontal yellow bars of equal length.

**McKEON®**

# 1 | Elevator Separation

**Elevator Lobbies & Hoistway Protection**

**Elevator Smoke & Draft**



# ELEVATOR SEPARATION

# Elevator Lobbies & Hoistway Protection

## Section 3006

Hoistway protection is designed to isolate fire, smoke, heat and toxic gases or fumes from migrating floor to floor through vertical hoistways in multi-story structures. There are two fundamental methods prescribed in this code section – elevator lobbies or protection at the point of access to the elevator car.

### Fire & Life Safety Concerns

Elevator shafts are the most common inter-connecting vertical shafts in multi-story buildings. These shafts become conduits for fire, heat, smoke and other toxins between the fire floor(s) and additional floors.

### Code Requirements

**3006.1 General.** Elevator hoistway openings and enclosed elevator lobbies shall be provided with the following:

1. Where hoistway opening protection is required by Section 3006.2, such protection shall be in accordance with Section 3006.3.
2. Where enclosed elevator lobbies are required for underground buildings, such lobbies shall comply with Section 405.4.3.
3. Where an area of refuge is required and an enclosed elevator lobby is provided to serve as an area of refuge, the enclosed elevator lobby shall comply with Section 1009.6.
4. Where fire service access elevators are provided, enclosed elevator lobbies shall comply with Section 3007.6.
5. Where occupant evacuation elevators are provided, enclosed elevator lobbies shall comply with Section 3008.6.

**3006.2 Hoistway opening protection required.** Elevator hoistway door openings shall be protected in accordance with Section 3006.3 where an elevator hoistway connects more than three stories, is required to be enclosed within a shaft enclosure in accordance with Section 712.1.1 and any of the following conditions apply:

# ELEVATOR SEPARATION

---

1. The building is not protected throughout with an automatic sprinkler system in accordance with Section 903.3.1.1 or 903.3.1.2.
2. The building contains a Group I-1 Condition 2 occupancy.
3. The building contains a Group I-2 occupancy.
4. The building contains a Group I-3 occupancy.
5. The building is a high rise and the elevator hoistway is more than 75 feet (22 860 mm) in height. The height of the hoistway shall be measured from the lowest floor to the highest floor of the floors served by the hoistway.

## Exceptions:

1. Protection of elevator hoistway door openings is not required where the elevator serves only open parking garages in accordance with Section 406.5.
2. Protection of elevator hoistway door openings is not required at the level(s) of exit discharge, provided the level(s) of exit discharge is equipped with an automatic sprinkler system in accordance with Section 903.3.1.1.
3. Enclosed elevator lobbies and protection of elevator hoistway door openings are not required on levels where the elevator hoistway opens to the exterior.

**3006.2.1 Rated Corridors.** Where corridors are required to be fire-resistance rated in accordance with Section 1020.1, elevator hoistway openings shall be protected in accordance with Section 3006.3.

**3006.3 Hoistway opening protection.** Where Section 3006.2 requires protection of the elevator hoistway door opening, the protection shall be provided by one of the following:

1. An enclosed elevator lobby shall be provided at each floor to separate the elevator hoist-

way shaft enclosure doors from each floor by fire partitions in accordance with Section 708. In addition, doors protecting openings in the elevator lobby enclosure walls shall comply with Section 716.5.3 as required for corridor walls. Penetrations of the enclosed elevator lobby by ducts and air transfer openings shall be protected as required for corridors in accordance with Section 717.5.4.1.

2. An enclosed elevator lobby shall be provided at each floor to separate the elevator hoistway shaft enclosure doors from each floor by smoke partitions in accordance with Section 710 where the building is equipped with an automatic sprinkler system installed in accordance with Section 903.3.1.1 or 903.3.1.2. In addition, doors protecting openings in the smoke partitions shall comply with Sections 710.5.2.2, 710.5.2.3 and 716.5.9. Penetrations of the enclosed elevator lobby by ducts and air transfer openings shall be protected as required for corridors in accordance with Section 717.5.4.1. Note: Smoke partitions as defined in Section 710.3 are not required to be fire rated. The doors located in smoke partition walls referenced in Section 710.5.2.2 are required to be UL 1784 labeled as smoke & draft control assemblies.
3. Additional doors shall be provided at each elevator hoistway door opening in accordance with Section 3002.6. Such door shall comply with the smoke and draft control door assembly requirements in Section 716.5.3.1 when tested in accordance with UL 1784 without an artificial bottom seal.
4. The elevator hoistway shall be pressurized in accordance with Section 909.21.

**3006.4 Means of egress.** Elevator lobbies shall be provided with at least one means of egress

# ELEVATOR SEPARATION

complying with Chapter 10 and other provisions in this code. Egress through an elevator lobby shall be permitted in accordance with Item 1 of Section 1016.2.

## Design Solutions

A diverse line-up of McKEON door assemblies can easily accommodate wide-span openings, radius applications, and egress.

### CASE 1: Side Acting Accordion with Power-assisted Egress

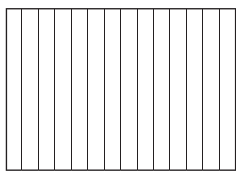

In the first case study, there is no headroom and side stacking space is limited. The McKEON bi-parting accordion fire door technology stepped up to meet the demand of hi-end design without compromising specific code requirements including conforming side acting accordion fire door egress acceptance.

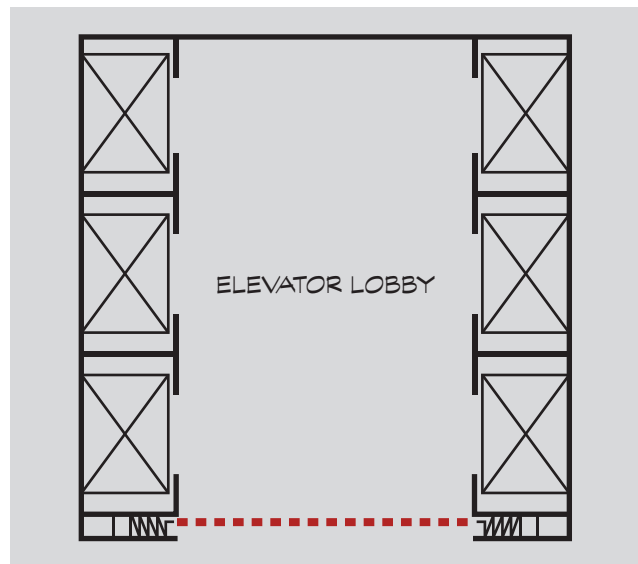

# ELEVATOR SEPARATION

## CASE 2: Side Acting Accordion with Complying Swing Egress Door & Vertical Acting with Complying Swing Egress Door(s)

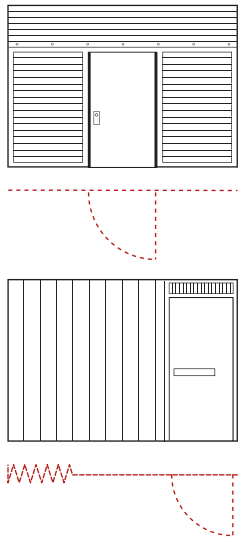

This case study includes both a side acting accordion with conventional egress elevator lobby separation and a vertical acting with conventional egress smoke barrier opening protective.

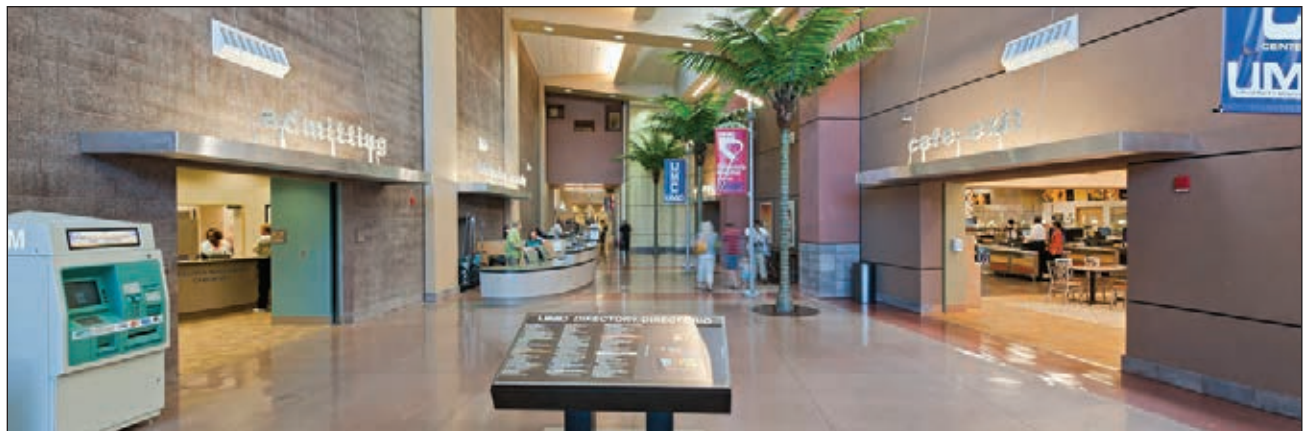
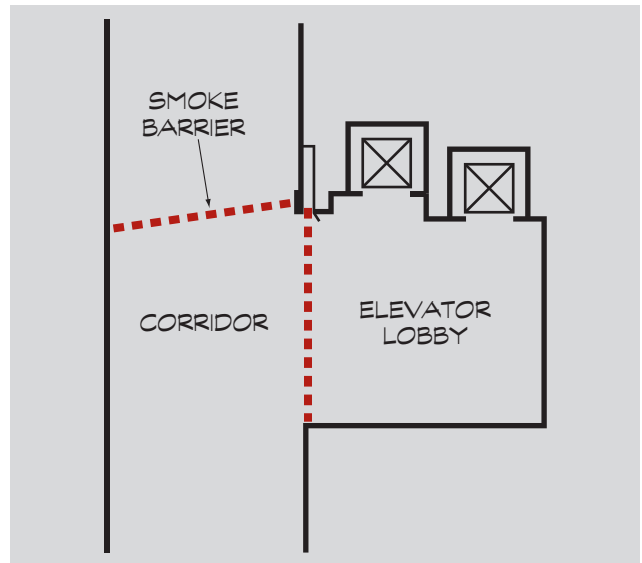

# ELEVATOR SEPARATION

## CASE 3: Side Acting Accordion with Power-assisted Egress

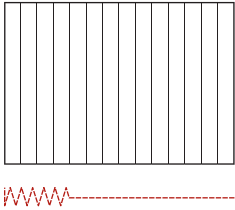

The side acting accordion technology will accommodate custom radius applications as well as serve as the primary means of egress from the space.

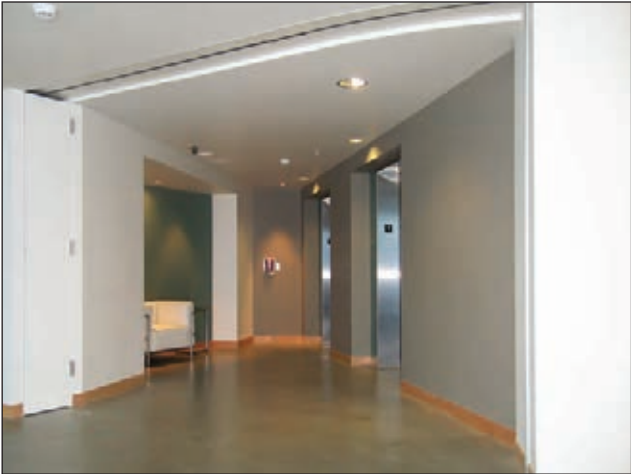
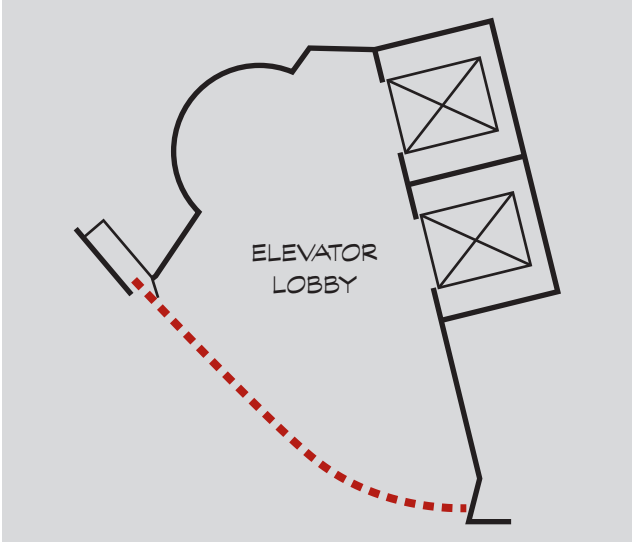

# ELEVATOR SEPARATION

## CASE 4: Vertical Acting with Multiple Complying Swing Egress Doors

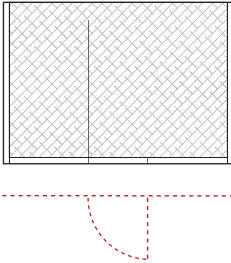

This project introduces the use of fire protective curtain assemblies that have been approved in accordance with the current editions of the model buildings codes (see IBC Section 3006.3, Item #2. Specific reference

to this technology is now approved as opening protectives without hose stream performance [UL 10D 20-minute fire rated] for publication in the 2021 edition of the IBC [See Appendix, Resource IBC 2021]).

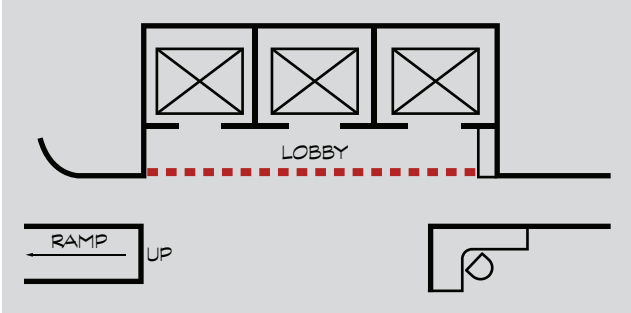

# ELEVATOR SEPARATION

## CASE 5: Vertical Acting without Egress

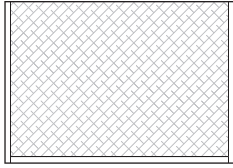

For the same reasons of acceptance explained in CASE 4, Fire Protective Curtain Assemblies satisfied two code compliance challenges in this design. Even though an elevator lobby is not necessarily required on the level of exit discharge in a sprinklered building, this separation takes on the form of a lobby since it protects the remaining structure from the vertical features of the building. Egress is not required though the fire protective curtain due to exiting out of the lobby or separated space through the main entrance.

Specific reference to this technology is now approved as opening protectives without hose stream performance (UL 10D 20-minute fire rated) for publication in the 2021 edition of the IBC (See Appendix, Resource IBC 2021).

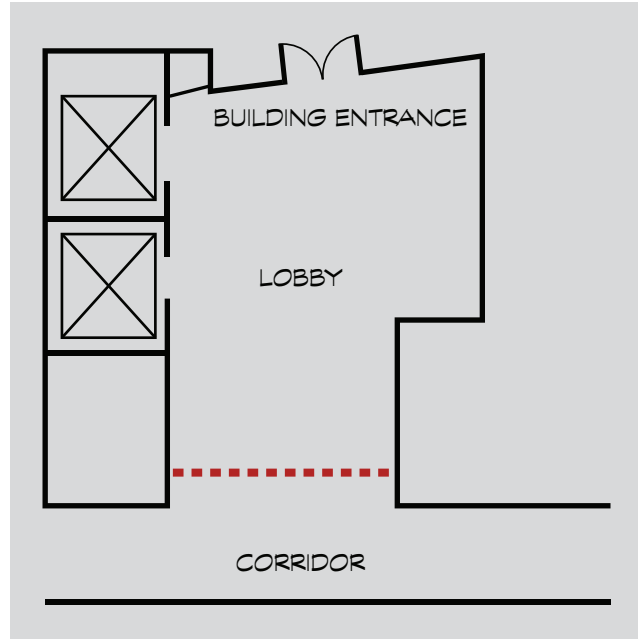

# ELEVATOR SEPARATION

---

## Inquiry Discussion & Questions

There has been much discussion in the regulatory arena about the purpose and usefulness of the elevator lobby. It can be argued the lobby is a dual application fire and life safety component of the structure, a barrier against smoke migration in and out of the vertical shaft as well as an area of refuge for building occupants. These fundamental occupant safety features are tempered with sprinkler exceptions but consistently remain as salient provisions each code development cycle.

If there is a trend in preference it appears to be for more passive redundant protection surrounding the elevator shaft rather than less. For example, the code requirements outlined in this application study include several sprinkler exceptions that allow the elimination of the elevator lobby for normal-use passenger elevators in Section 3006. However, once the building goes into alarm, Section 3007 Fire Service Access Elevator and Section 3008 Occupant Evacuation Elevators do not allow the same exceptions. Not only are lobbies required in these two applications, with no exemptions, each lobby must be fully fire and smoke rated with prescribed physical size requirements. Interestingly, in a fire event the elevator often becomes an integral part of the means of egress system.

Elevator lobbies can be considered a viable choice based on three premises. Let's use the layout as diagrammed in Case Study #2 as an example. First, from a design ambiance perspective, it is cumbersome to provide independent separation at the point of each elevator car to simply eliminate the lobby. The space would certainly be interrupted at each elevator car opening. A single separation creating a full space lobby would have less impact on the overall design. Secondly, a single separation opening protective is clearly less costly than multiple systems located at each car opening. The third and perhaps the most important consideration is fire and life safety. By creating a conforming full space lobby we stop smoke and heat from penetrating the shaft, and provide an area of refuge for building occupants. In other words, rather than provide closures at each individual point-of-access location to the elevator car, why not create an elevator lobby that is unobstrusive, costs less and will adequately serve as an area of refuge.



# ELEVATOR SEPARATION

# Elevator Smoke & Draft

## Section 3006.3

Elevator car doors are typically fire-rated but cannot comply with smoke and draft requirements. Smoke & draft rated assemblies eliminate the passage of smoke and are usually located at the point of access to an elevator car as an alternative to the elevator lobby.

### Fire & Life Safety Concerns

Elevator shafts commonly represent the majority of inter-connecting vertical shafts in multi-story buildings. These shafts become conduits for heat, smoke and other toxins between the fire floor(s) and additional floors. In buildings with more than three interconnected stories, the conventional elevator lobby is designed to stop the spread of fire and smoke before it reaches the elevator shaft enclosure doors. However, if the lobby is eliminated smoke could quickly penetrate the shaft at the point of access. Thus, all fire-rated assemblies used at the point of access must maintain a smoke and draft rating. (*UL 1784*)

### Code Requirements

There are two primary provisions that drive the need for elevator protection in the IBC. First, Section 3006.2 requires protection where the elevator hoistway connects more than three stories and any of the following conditions apply:

1. The building is not protected throughout with sprinklers ...
2. The building contains an I-1 Condition 2 occupancy
3. The building contains an I-2 occupancy
4. The building contains an I-3 occupancy
5. The building is a hi-rise ... more than 75 feet

The second primary provision is found in Section 3006.2.1 requiring elevator hoistway protection when the corridors in the structure are fire-resistance rated.

# ELEVATOR SEPARATION

Section 3006.3, Item #3 allows the elimination of the lobby by placing a minimum UL 1784 (smoke) rated assembly at the point of access to the elevator hoistway door opening. Please note: All assemblies located at the point of access to an elevator car must be readily openable from the car side without a key, tool, special knowledge or effort. (3002.6)

## Design Solutions

### CASE 1: Side Acting Accordion with Power-assisted Egress

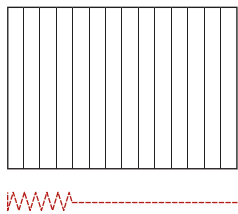

Due to the several configuration options of the McKEON door assemblies multiple or single elevator openings can easily be protected. Egress can be placed at each elevator car door opening to accommodate conforming exit requirements.

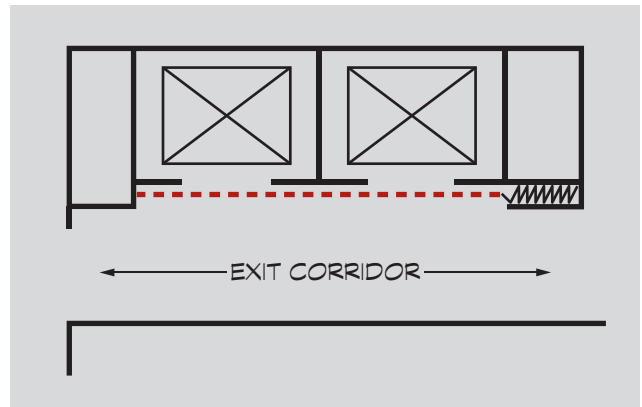

# ELEVATOR SEPARATION

## CASE 2: Side Acting Accordion with Manual Egress

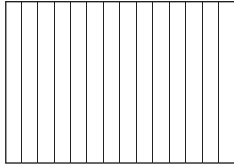

This simple, manually operated, bolt-up pre-fabricated unit can be installed at the point of access to any elevator car in a matter of hours. No pocket, stud or drywall construction is necessary. The door, held open by an electromagnet, is released at the command of a smoke detector and the fire and smoke rated assembly closes. Building occupants or first responders can pass through the opening as the door self-closes behind them.

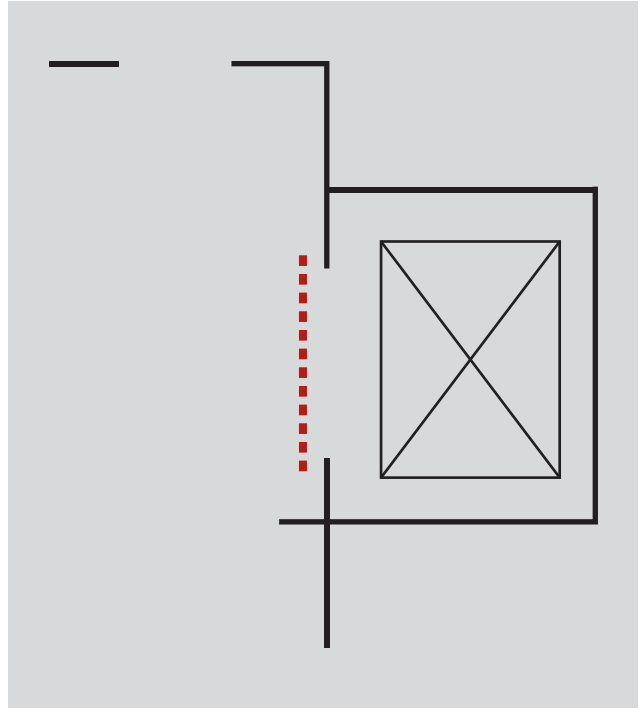

# ELEVATOR SEPARATION

## CASE 3: Vertical Coiling with Complying Swing Egress Door(s)

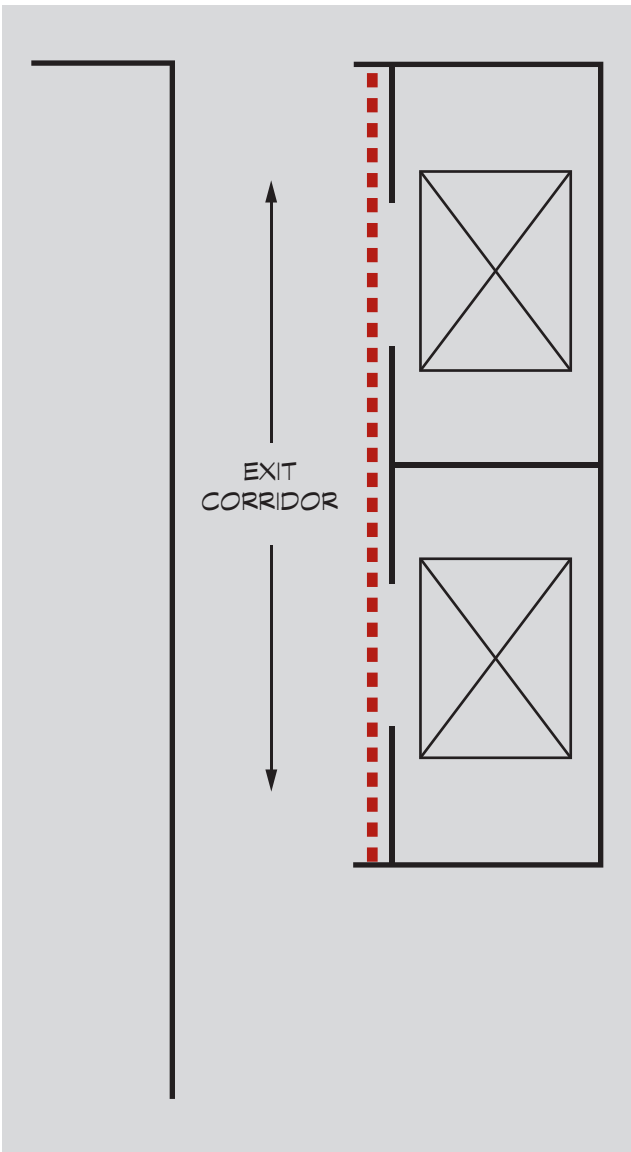
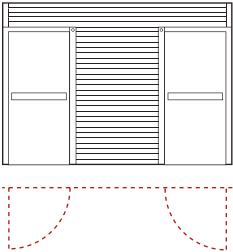

# ELEVATOR SEPARATION

## CASE 4: Side Acting Accordion with Power-assisted Egress

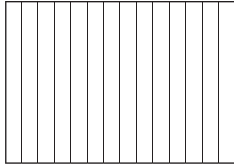

The single track 3-hour rated accordion will accommodate 18" radius to custom curves. Along with complying egress, McKEON resolved a very difficult challenge without life safety or design compromise.

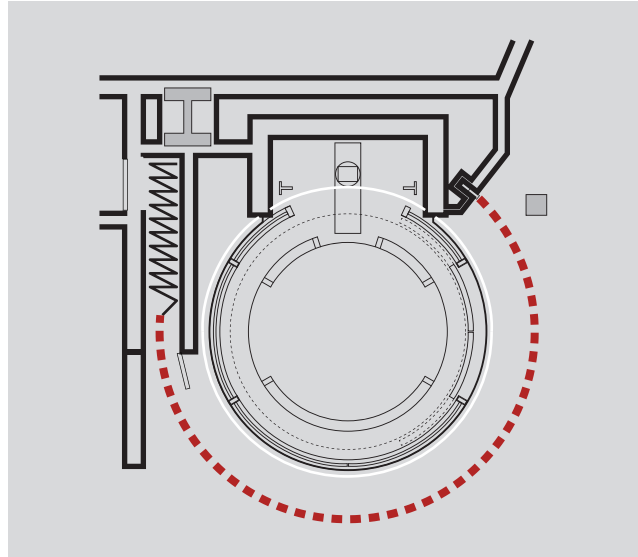

# ELEVATOR SEPARATION

## CASE 5: Vertical Acting with Egress

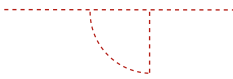
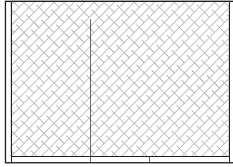

Typically, the elevator car or elevator shaft door is fire rated but does not carry a UL 1784 smoke rating. The SmokeFighter® D150E is a listed and labeled UL 1784 assembly with a complying egress feature. Located at the point of access to the elevator car, this assembly protects the opening mitigating smoke migration.

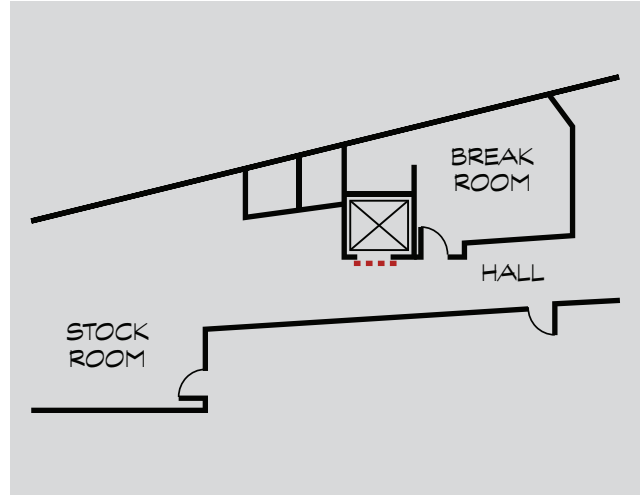

# ELEVATOR SEPARATION

## CASE 6: Vertical Acting with Egress

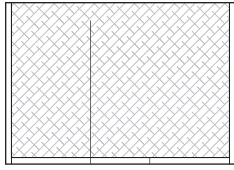

Similar to the previous case study, the elevator car or elevator shaft door is fire rated but does not carry a UL 1784 smoke rating. But on this project the design team elected to use the FireFighter® D200E which is listed and labeled as a 20-minute UL 10D & UL 1784 assembly with a complying egress feature. By applying the 20-minute fire-rated assembly in this design, McKEON provided redundancy in the fire-rated requirements. Located at the point of access to the elevator car, this assembly protects the opening mitigating smoke migration as well as fire and heat penetration.

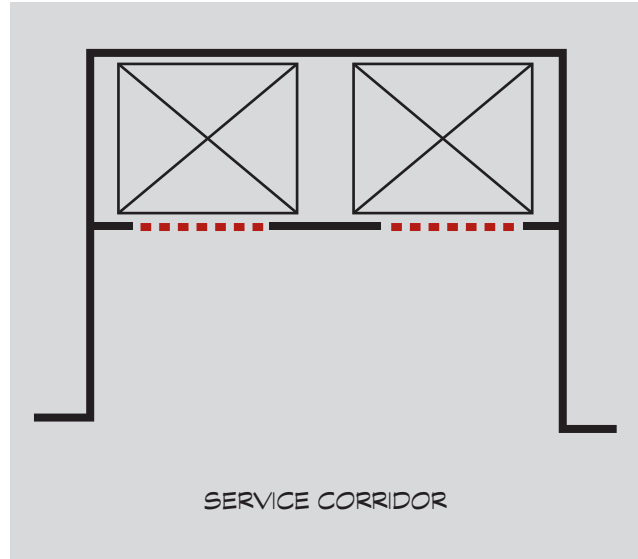









**McKEON®**

# 2 | Exit Access Separation

**Horizontal Exit**

**Exit Passageways**

**Pedestrian Walkways & Tunnels**

# EXIT ACCESS SEPARATION

## Horizontal Exit

### Section 1026

Horizontal exits are designed to move building occupants on a floor from any point in the exit access system to a fire and smoke protected area.

#### Fire & Life Safety Concerns

The horizontal exit differs fundamentally from the typical code-defined exit. The horizontal exit is meant to “defend in place” by creating an area of safe refuge for building occupants within the confines of the building structure. All other exits are designed to exit occupants out of and away from the building.

#### Code Requirements

Because building occupants are not being removed from the building when using the horizontal exit, specific precautionary requirements are based upon the following fundamental principles:

**Principle #1:** Separation. A 2-hour fire wall or fire barrier must be used to separate safe refuge areas connected with a horizontal exit (*Section 1026.2*). The determination between the use of a wall, fire barrier or horizontal assembly is the function of the wall as it relates to other code requirements.

**Principle #2:** Opening Protective. The opening within the horizontal exit must be protected with a self-closing or automatic closing fire door when activated by a smoke detector. The fire rating of the door must be a minimum of 90 minutes. (*Section 1026.3*)

**Principle #3:** Area of Refuge Capacity. Based on a net floor allowance of 3 square feet for each person with the following guidelines:

Where the horizontal exit also forms a smoke compartment, the capacity of the refuge area for Group I-1, I-2 and I-3 occupancies and Group B ambulatory care facilities shall comply with Section 407.5.3, 408.6.2, 420.6.1 and 422.3.2 as applicable.

**Principle #4:** Number of Exits. The refuge area into which a horizontal exit leads shall be provided with exits adequate to meet the occupant requirements of this chapter, but not including the added

# EXIT ACCESS SEPARATION

occupant load imposed by persons entering the refuge area through horizontal exits from other areas. Not less than one refuge area exit shall lead directly to the exterior or to an interior exit stairway or ramp.

Exception: The adjoining compartment shall not be required to have a stairway or door leading directly outside, provided the area of refuge area into which a horizontal exit leads has stairways or doors leading directly outside and are so arranged that egress shall not require the occupants to return through the compartment from which egress originates.

## Design Solutions

### CASE 1: Side Acting Accordion with Complying Swing Egress Door

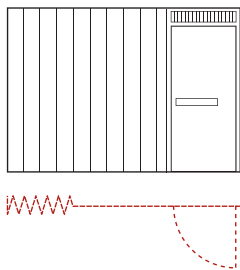

The intent is to add a 10,200 square foot critical care suite onto an existing I-2 (hospital). However code requirements come into play that affect the design dramatically:

- First, suites of sleeping rooms cannot exceed 10,000 square feet in a sprinklered structure. In this case a 10,200 square foot suite is being added. (407.4.3.5.1)
- Second, there must be two exits from each suite. (407.4.4.5.1)
- Third, the travel distance between any point in a suite of sleeping rooms and an exit access exit door shall not exceed 125 feet with automatic smoke detection. (407.4.4.3)

By utilizing the horizontal exit concept, the following will preserve the original design intent and provide code compliance:

- Separate the intended 10,200 square foot space into two suites, each less than 10,000 square feet.
- Provide a 2-hour fire barrier wall as the separation. (Section 1026.2)
- Provide a horizontal exit in the separation as one of two required exits from each space. (Section 407.4.4.5.2)
- Provide a 90-minute opening protective. (Table 716.5)

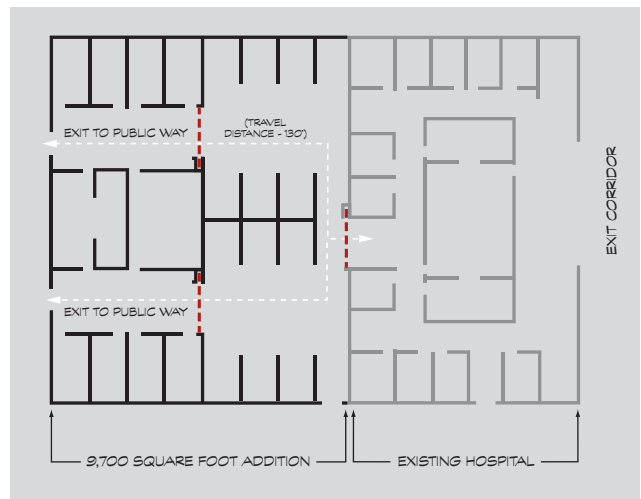

# EXIT ACCESS SEPARATION

## CASE 2: Vertical Coiling with Complying Swing Egress Door(s)

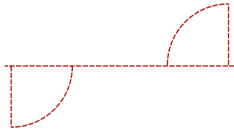
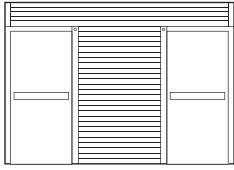

McKEON offers a particularly unique resolve for this airport design. Because the concourse is located above ground level and in a TSA secure area, it is not possible to provide exiting to the exterior. Also, there is not room for build-outs or

pocket spaces, therefore unique to the T2500 technology a 90-minute opening protective is provided with no side room and as little as 26 inches of head-room with conforming dual egress doors. In essence each side of a long fire and smoke rated concourse forms one of two areas of refuge.

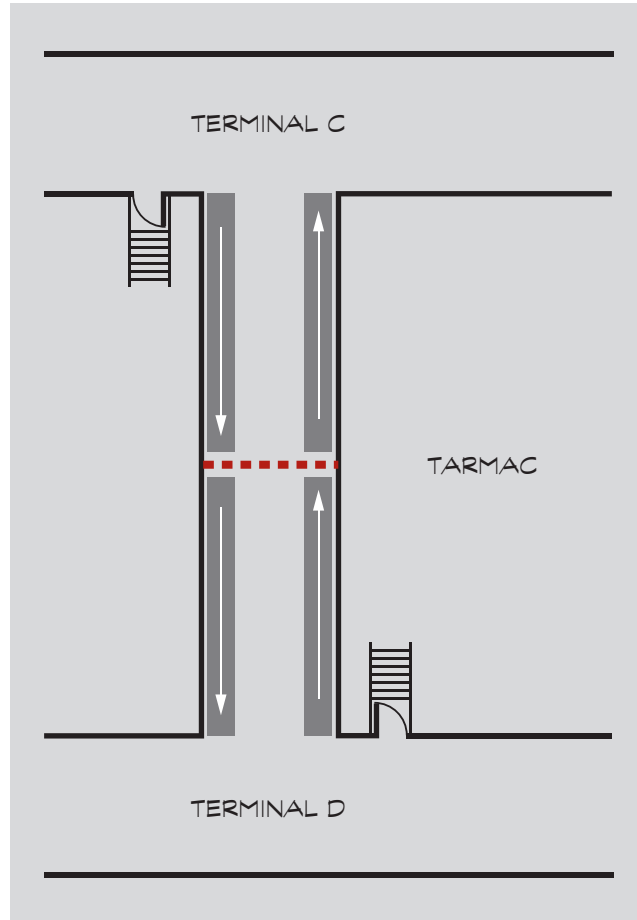



# EXIT ACCESS SEPARATION

## Exit Passageways

### Section 1024

An exit passageway provides the designer with an acceptable way of connecting a required exit stair to the exit discharge. Because the code requires an exit stair to open directly into an exit discharge to the exterior of the building, this provision will allow the stair to terminate at convenient locations away from the exterior walls. Also, the exit passageway can extend the path of travel when travel distances in the exit access system have been exceeded.

#### Fire & Life Safety Concerns

Extending the path of egress beyond the terminated travel distance or beyond the exit vestibule increases the potential for building occupants to be exposed to fire, smoke or hot and toxic gases. For these reasons exit passageways are designed with more strict provisions.

#### Code Requirements

1. An exit passageway shall not be used for any purpose other than as a means of egress. *(1024.1)*
2. Exit passageway enclosures shall have walls, floors and ceilings of not less than 1 hour ... and be constructed as fire barriers or horizontal assemblies. *(1024.3)*
3. Elevators shall not open into an exit passageway. *(1024.5)*
4. Opening protectives shall comply with Section 716 ... and shall be limited to those necessary for exit access into the exit passageway from normally occupied spaces and for egress from the exit passageway. *(1024.5)*
5. Where an interior exit stairway or ramp is extended to an exit discharge or a public way by an exit passageway, the exit passageway shall comply with Section 1023.3.1. In other words, the interior exit stair must be separated from the exit passageway by a fire barrier wall equal in rating to the requirement for the interior exit stairway.

# EXIT ACCESS SEPARATION

## Design Solution

### CASE 1: Vertical Coiling with Complying Swing Egress Door(s)

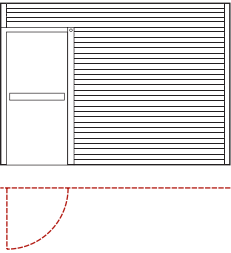

In this case study the required exit stair from the floors above terminated several feet from the exterior of the building. The McKEON opening protective forms the rated enclosure during a fire emergency, extending the exit path to exit discharge.

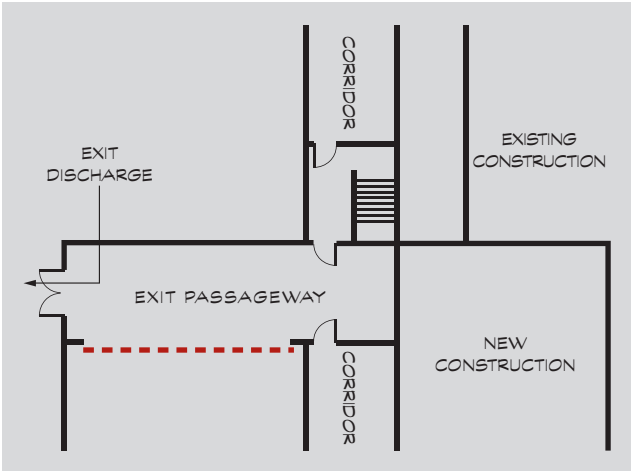



# EXIT ACCESS SEPARATION

---

## Inquiry Discussion and Questions

Because exit passageways are constructed under strict opening provisions, designs rarely incorporate them unless there is no other choice. With the use of the McKEON wide-span opening protectives, openings are not limited in size and little or no design compromise is noticed by building occupants. The following questions can be helpful in assisting the design professional to recognize new options:

- Have you ever desired to terminate a required exit enclosure on the interior of the building rather than at the exterior exit?

- Do you find challenges in connecting an exit enclosure with the exit to the exterior of the building?
- Did you know that solving a travel distance problem by providing an exit passageway can open your design rather than close it down?

### Notes:

---

---

---

---

---

---

---

---

---

---

---

---

---

---

---

---

---

---

---

---

---

---

---

---

## EXIT ACCESS SEPARATION

# Pedestrian Walkways & Tunnels

## Section 3014

Walkways and tunnels are designed to provide connection between buildings. They can be located at, above or below grade level and are used as a means of travel by persons.

### Fire & Life Safety Concerns

Buildings located across lot lines from each other are required to have fire-rated exterior walls to prevent fire and smoke from passing between them (705; Table 602). Walkways and tunnels that connect and penetrate these rated exterior walls compromise this protection, potentially allowing heat and smoke to pass from one building to another.

### Code Requirements

Section 3104 details specific requirements to ensure building occupant safety based upon the following fundamental principles:

**Principle #1: Separate Structures.** Connected buildings shall be considered to be separate structures (3104.2). Unless the buildings are all on the same lot or exempt under specific accessibility requirements each building will be considered as a separate building when determining fire resistance, exterior wall ratings and egress.

**Principle #2: Construction.** The pedestrian walkway shall be of noncombustible construction (3104.3). Unless each building being connected is of combustible construction the connecting element must be noncombustible to minimize the travel of heat and smoke.

**Principle #3: Fire Barriers.** Once the rated exterior walls have been penetrated to accommodate a noncombustible connecting walkway, the interior of each building must be further protected with fire barriers of not less than 2-hour rated construction (3104.5.1). In order to avoid this requirement the following criteria must be met:

- A. Exterior walls - 2 hour rated, extend not less than 10' in every direction surrounding the perimeter of the pedestrian walkway.

# EXIT ACCESS SEPARATION

- B. Openings in exterior walls of connected buildings - opening protectives not less than 3/4 hour.
- C. Supporting construction - See Section 707.5.1.

## Principle #4: Alternative Separation

- A. Distance between connected buildings is more than 10 feet.
- B. Walkway and connected buildings fully sprinklered.
- C. The wall shall be capable of resisting smoke.
- D. The wall and doors can be constructed of wired or tempered glass that is protected with sprinklers. All glass in gasketed frames.

## Design Solutions

The alternatives to fire barrier separations as listed above are very costly. Complying with the 2-hour separation requirement in Section 3104.5 is the least expensive option. A listed and labeled wide span McKEON assembly will easily protect any size opening. In the following case studies, McKEON showcases three distinctly different technologies to resolve the same code application problem. Diverse design requirements were not a challenge, rather routine applications of standard products.

### CASE 1: Vertical Coiling with Complying Swing Egress Door(s)

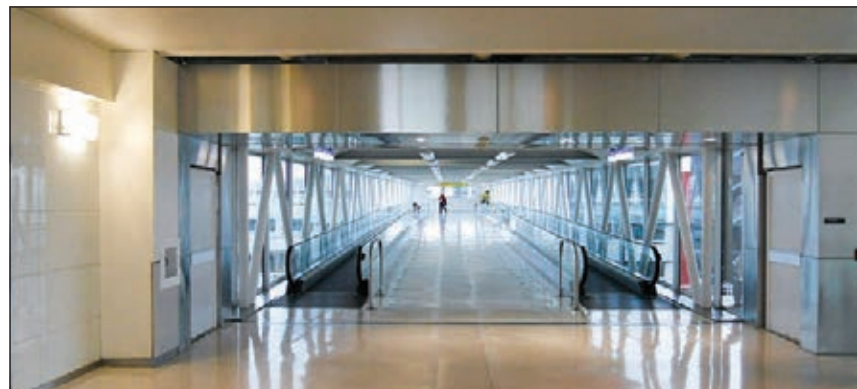
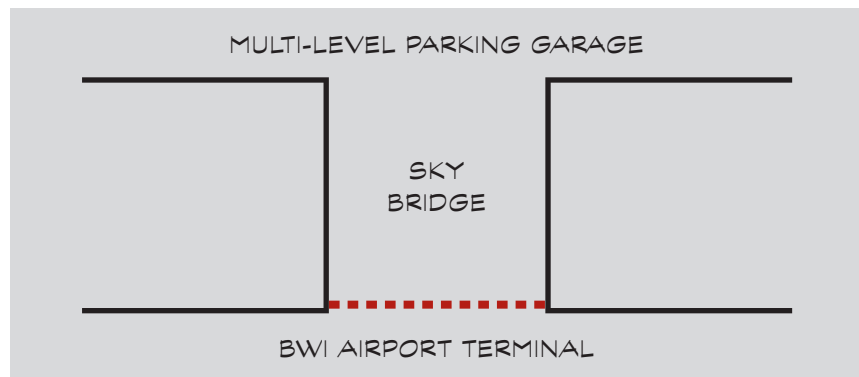
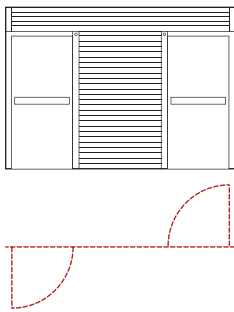

# EXIT ACCESS SEPARATION

## CASE 2: Side Acting Accordion with Power-assisted Egress

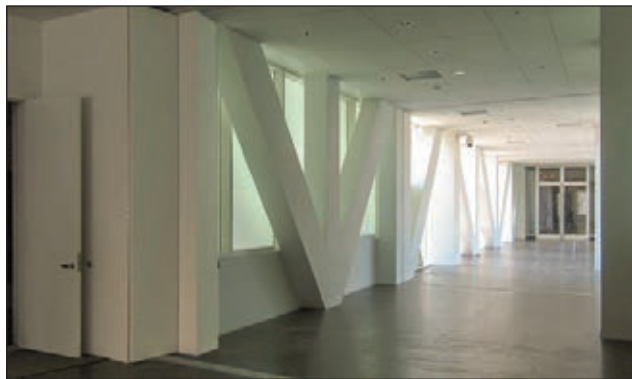
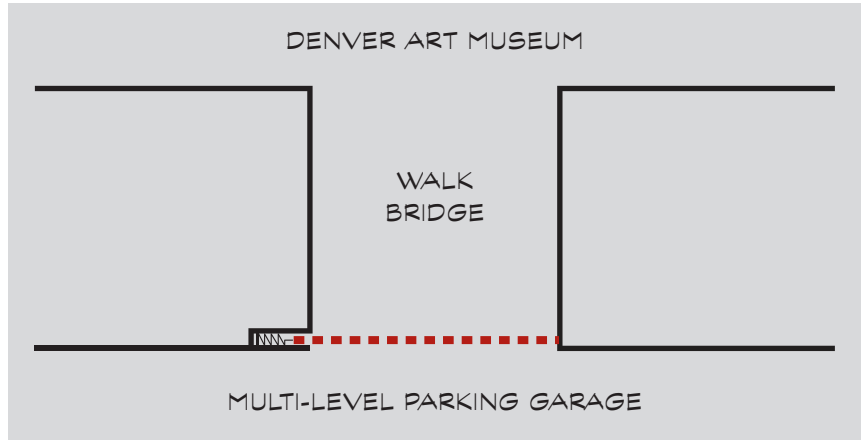
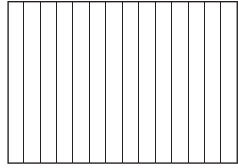

## CASE 3: Side Coiling without Egress

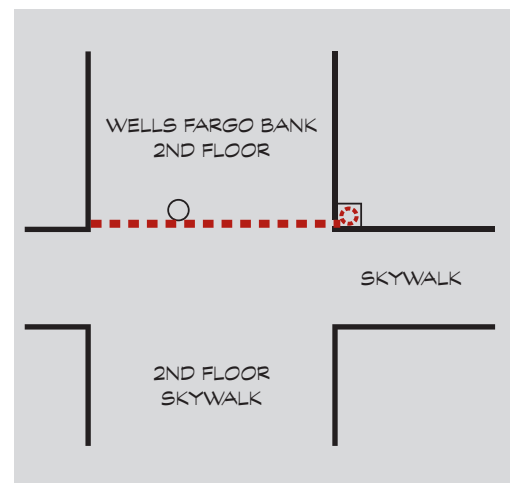
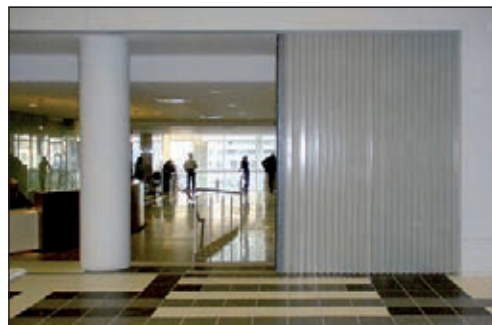
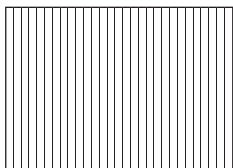

# EXIT ACCESS SEPARATION

---

## Inquiry Discussion and Questions

Pedestrian walkways can be located overhead connecting two or more buildings or underground as tunnels connecting two or more buildings. This connecting construction is viewed as a definite threat to life safety. The code attempts to build in safety measures that are intended as substitutes for complete and optimum separation. These substitutes include extensive active wet sprinkler systems, open side walls, and tempered and/or wire glass components. It would certainly make more sense to use the “real thing” by easily providing rated barriers with wide-span opening protectives at each end eliminating any threat of fire and smoke entering the walkways.

The following questions may be helpful:

- Have you been able to run a cost comparison separating the building from the walkway as opposed to protecting the walkway?
- Even though a pedestrian walkway will most likely be constructed of non-combustible materials, would you like to avoid the cost of sprinklers, limiting interior design and costly tempered and/or wired glass components?

### Notes:

---

---

---

---

---

---

---

---

---

---

---

---

---

---

---

---

---

---

---

---

---

---

---

---

# **3** | Vertical Opening Separation

**Fundamental Guidelines**

**Draft Curtains**

**Exit Access Stairways**

**Vertical Openings – Escalator**

**Interior Exit Stairways**

**Atriums**

**Vertical Compartmentation**

# VERTICAL OPENING SEPARATION

## Fundamental Guidelines

Sections 404, 712, 713, 1019, 1023 & 1027

**Vertical openings between floors are designed consistently in multi-story buildings in many different shapes, heights and uses. For the purposes of code enforcement the following general categories are described in the building code:**

- 1. Shaft Enclosures (713)**
  - a. Escalators (712.1.3)**
  - b. Mezzanines (712.1.11, 505)**
  - c. Stairs (712.1.12, 1019, 1023, 1027)**
  - d. Elevators (3006)**
- 2. Atriums (404)**
- 3. Interior Exit Stairways and Ramps (Section 1023)**
- 4. Exit Access Stairways (712.1.12, 1019)**

Typically anytime two or more floors are open to each other a vertical opening is created and the phrase “floors are common with each other” is used to characterize the condition.

Two fundamental principles drive the requirements of vertical opening protection. First, the migration of smoke, heat and toxic gases floor to floor. Second, egress of building occupants from upper levels to a safe level of exit discharge.

The case studies in this section illustrate the balance between these two principles in the enforcement of fire & life safety provisions for building occupants in multi-story buildings.

# VERTICAL OPENING SEPARATION

## Understanding Draft Curtains & Closely Spaced Sprinklers as Vertical Space Fire Protection Features

### Sections 712.1.3.1 & 1019.3, #4

Draft curtains and closely spaced sprinklers, in accordance with NFPA 13, may be used in lieu of shaft enclosure construction in specific vertical opening applications.

Because of the chimney effect that can take place in vertical openings in multi-story structures, smoke, heat, toxic fumes and gases easily transfer throughout the structure. The optimum regulatory provision that prevents or mitigates this condition is the construction of solid fixed walls that are fire-rated as shaft enclosures separating vertical spaces from the remaining structure and floor areas. However, certain conditions allow the use of draft curtains in lieu of Fire Barrier walls.

Draft curtains are intended to accelerate the activation of sprinklers placed around the perimeter of vertical openings in order to provide an instant water barrier. This is a level of protection that can take the place of the rated wall construction and mitigate the transfer of smoke, heat, toxic fumes and gases which may be transferring vertically through the structure during a fire event.

The code addresses the use of draft curtains in two specific applications only. Both are penetrations through floor openings with the first being the escalator and the second, exit access stairways.

### Escalator Openings

**Section 712.1.3 Escalator openings.** Where a building is equipped throughout with an automatic sprinkler system in accordance with Section 903.3.1.1, vertical openings for escalators shall be permitted where protected in accordance with Section 712.1.3.1 or 712.1.3.2.

**Section 712.1.3.1 Opening size.** Protection by a draft curtain and closely spaced sprinklers in accordance with NFPA 13 shall be permitted where the area of the vertical opening between stories does not exceed twice the horizontal projected

area of the escalator. In other than Groups B and M, this application is limited to openings that do not connect more than four stories.

**Section 712.1.3.2 Automatic shutters.** (Please see the application study in this document titled, “Vertical Openings – Escalator.”)

The use of the draft curtains with closely spaced sprinklers in escalator openings as outlined in the aforementioned code language only applies when the area of the escalator itself obstructs at least half of the area of the opening being pen-



# VERTICAL OPENING SEPARATION

etrated. The following diagram illustrates a compliant application of this criteria. It is important to remember, this condition is acceptable only when the building is fully sprinklered.

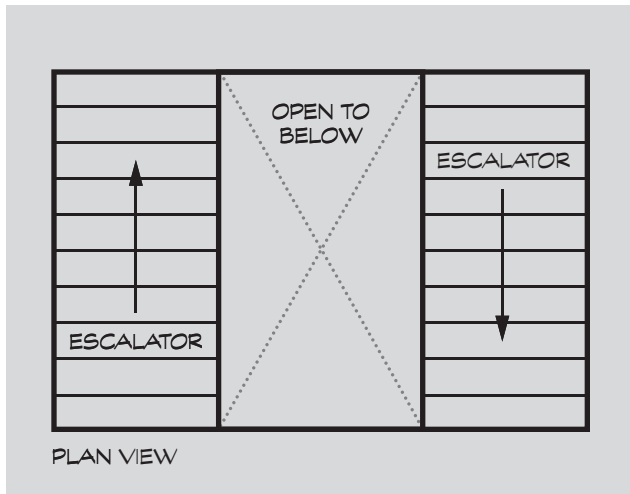

## Exit Access Stairway Openings

**Section 1019.3 Occupancies other than I-2 and I-3.** In other than Group I-2 and I-3 occupancies, floor openings containing exit access stairways or ramps that do not comply with one of the conditions listed in this section shall be enclosed with a shaft enclosure constructed in accordance with Section 713.

Condition 4. Exit access stairways and ramps in buildings equipped throughout with an automatic sprinkler system in accordance with Section 903.3.1.1, where the area of the vertical opening between stories does not exceed twice the horizontal projected area of the stairway or ramp and the opening is protected by a draft curtain and closely spaced sprinklers in accordance with NFPA 13. In other than Group B and M occupancies, this provision is limited to openings that do not connect more than four stories.

Using language similar to the escalator provisions, the use of draft curtains with closely spaced sprinklers in exit access stairway openings only applies when the area of the stair, to include any landings, obstructs at least half of the area of the opening being penetrated. The diagram below illustrates a compliant application of this criteria. It is important to remember, this condition is acceptable only when the building is fully sprinklered.

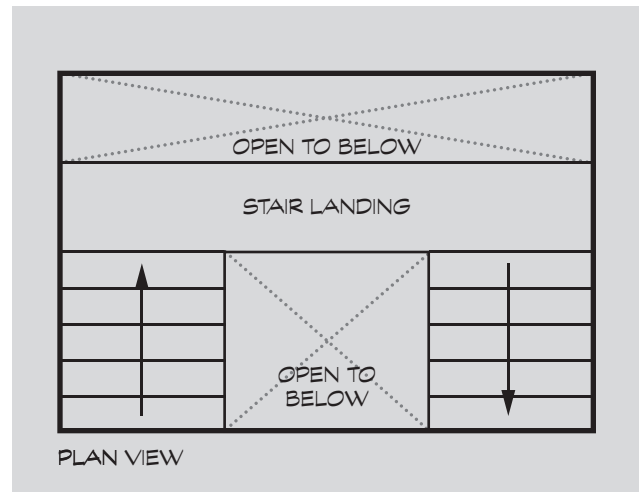

## A Code Discussion for Clarification

The design and code provisions governing the application and use of draft curtains do not require side-guide components or fire endurance testing and do not parallel typical opening protective acceptance criteria. Since the adoption and development of the *2015 edition of the International Building Code (IBC)*, the use of draft curtains in any project are for the sole purpose of creating barriers to force heat to activate sprinkler heads in vertical openings such as escalators and exit access stairways. Draft curtains are not intended to prevent smoke from migrating floor to floor, rather their purpose is to assist in immediate activation of the closely spaced sprin-

# VERTICAL OPENING SEPARATION

---

klers, associated with them, which are intended to mitigate the migration of smoke and/or heat floor to floor.

## Background

In the legacy model building codes and all editions of the IBC prior to the published 2015 edition, draft curtains were a requirement in two separate areas of the code with criteria and detailed definition in one area only. First, we will explore the use where these criteria and definitions occurred, Factory and Storage occupancies, as defined in *Chapter 9, Fire Protection Systems*. *Section 910.3.5.1* stated: *Construction. Draft curtains shall be constructed of sheet metal, lath and plaster, gypsum board or other approved materials which provide equivalent performance to resist the passage of smoke. Joints and connections shall be smoke tight.* In essence, draft curtains could be constructed of cardboard and duct tape ... as long as they channeled smoke.

This code language was written around the stringent requirements of Group F-1 and S-1 occupancies as indicated in *Table 910.3*. In these hi-pile storage occupancies there was no requirement for draft curtains to be fire rated, only that they “resist the passage of smoke.” Achieving smoke tight joints and connections were critical due to exceptions in the code section that allowed the reduction of smoke vents, their sizes and placement with the use of draft curtains. In other words, this specific language was confined to these two aforementioned occupancy types. Incidentally, this code requirement was eliminated in the 2015 edition of the IBC, the term draft curtain no longer exists for F-1 and S-1 occupancies. These particular smoke removal systems no longer require draft curtains for directing smoke.

## Current Provisions

*Section 712 Vertical Openings, 712.1.3.2* allows unprotected escalator openings that are protected by draft curtains. *Section 1019* addresses *Exit Access Stairways* allowing draft curtains to protect vertical openings. However, these two code sections (applications) did not reference *Section 910* prior to 2015 confirming separate and distinct uses of the provision. However, both the escalator and exit access stairway applications include a pointer to *NFPA 13* as the standard for the use of this building feature. *Section 712.1.3.1* *Opening size* at the escalator opening and *Section 1091.3, Item #4* at the exit access stairway opening state the following: “... protection[ed] by a draft curtain and closely spaced sprinklers in accordance with *NFPA 13* ...”

Please note, there are no other definitions or criteria for the term draft curtain in the model building codes with exception of the reference to *NFPA 13*. Yet, the term draft curtain is called out in both aforementioned code sections. Further to confuse the issue the term Draft Stop is found in *IBC Section 202*. After reading this definition, clearly it is addressing a building feature located in “... *concealed areas of building components such as crawl spaces, floor/ceiling assemblies, roof/ceiling assemblies and attics.*”

As if the issue is not confusing enough, *NFPA 13* addresses vertical openings such as escalator openings and stair openings with regard to this level of protection as Draft Stops rather than using the term Draft Curtain. Please note:

*NFPA 13, Section 8.15.4 Vertical Openings*

*8.15.4.1 General. Unless the requirements of 8.15.4.4 are met, where moving stairways, stair-*

# VERTICAL OPENING SEPARATION

---

*cases, or similar floor openings are unenclosed and where sprinkler protection is serving as the alternative to enclosure of the vertical opening, the floor openings involved shall be protected by closely spaced sprinklers in combination with draft stops in accordance with 8.15.4.2 and 8.15.4.3.*

*8.15.4.2 Draft Stops. Draft stops shall meet all of the following criteria:*

- 1. The draft stops shall be located immediately adjacent to the opening.*
- 2. The draft stops shall be at least 18 in. (457 mm) deep.*
- 3. The draft stops shall be of noncombustible or limited combustible material that will stay in place before and during sprinkler operation.*

The term draft curtain does appear in *NFPA 13*, however, only in reference to the old method of channeling smoke to smoke and heat vents in “F” & “S” occupancies. Therefore, the use of draft curtains in our current model building codes is limited to escalator and exit access stairway openings only. Since *NFPA 13* criteria for use of draft curtains in vertical openings does not require the channeling of smoke, rather to simply force heat and smoke against the sprinkler heads for immediate activation, the criteria does not include large depths of drop beyond 18 inches nor does it require smoke sealed corners or joints in the curtain installation.

If we examine this concept from a more pragmatic view we can see that the criteria makes sense. As mentioned above, the maximum drop in the draft stop criteria for these applications is 18 inches. If the intent of the draft curtain application was to stop the transfer of smoke or heat

to other floors, this depth would have to be much greater. At some point, very quickly upon contact the smoke will easily pass over these draft curtains and the curtains become academic at that point. Hence, draft curtain applications in escalators and stairs always have gaps at the joints, are typically constructed of polymethyl methacrylates which by trade-name are better known as clear acrylics or Plexiglass. These or other materials are usually not continuous or installed in a fashion to actually prevent smoke from migrating floor to floor ... their only purpose is to force enough heat against the sprinkler heads to activate them.

For this reason there is not a test standard or criteria for testing draft curtains. *NFPA 13* simply requires, “*The draft stops shall be of noncombustible or limited combustible material ...*” The D100 technology significantly exceeds these basic requirements. The McKEON SmokeFighter® Model D100 is manufactured from fabric that has been tested and certified for a 3-hour UL 10D fire label. This material has also been tested and certified for a 20 minute UL 10B fire label. Both labels certify use to span unlimited widths and heights. The test criteria included side-guide components in order to maintain full integrity opening protective hose stream performance.

The D100 technology exceeds the minimum requirements, creating a substantial fire and smoke barrier to expeditiously activate the closely spaced sprinklers surrounding the vertical opening. Sprinkler activation at the unprotected shaft opening mitigates the migration of heat, smoke, toxic fumes and gases from traveling throughout the structure.

# VERTICAL OPENING SEPARATION

## Exit Access Stairways

Sections 712, 1019

These case studies deal with a condition wherein several floors are common to each other. The floors are inter-connected with an interior exit access or communicating stairway. Previous editions of the code addressed these stair features as non-egress stairs. The code now defines Exit Access Stairways as a stairway within the exit access portion of the means of egress system. (202)

### Fire & Life Safety Concerns

Multiple floors open to each other is perhaps one of the most vulnerable conditions to fire danger threats in any multi-story building. Fire suppression is concerned with confining a fire to the floor of origin and preventing the fire, or the products of the fire (smoke, heat and hot/toxic gases) from spreading to other levels. Such conditions are not conducive to defend in-place strategies. Rather, it is preferable that building occupants move quickly out of harm's way. These requirements expressly demonstrate the overlap between passive, active and egress fire & life safety provisions.

### Code Requirements

In occupancies other than I-2 and I-3, floor openings containing exit access stairs that do not comply with one of the following ... shall be enclosed in a shaft enclosure. (1019.3)

- The exit access stairway must be included in the exit access travel distance measurement. (1017.3.1)
- Serve or atmospherically communicate between only two stories (1019.3, Item #1)
- Options to open four stories or more than four stories using draft curtains and closely spaced sprinklers (1019.3, Item #4, please see page 34, Draft Curtains)

For additional code language and acceptance criteria for two-story openings please see "Inquiry Discussion & Questions" on page 42 of this application study.

# VERTICAL OPENING SEPARATION

## Design Solutions

Because each space contains a stair the code will allow two floors common. In the following case studies, McKEON offers different products for very diverse design needs, yet there is not a compromise in fire and life safety.

### CASE 1: Vertical Coiling with Complying Swing Egress Door(s)

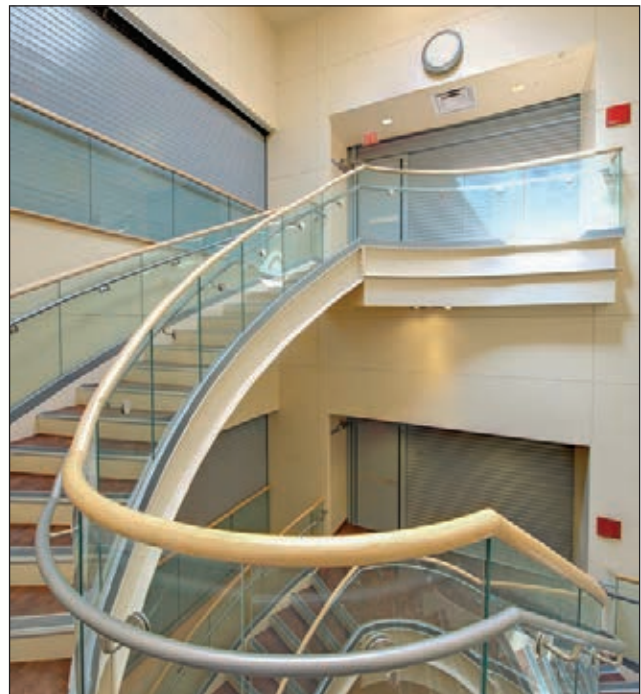
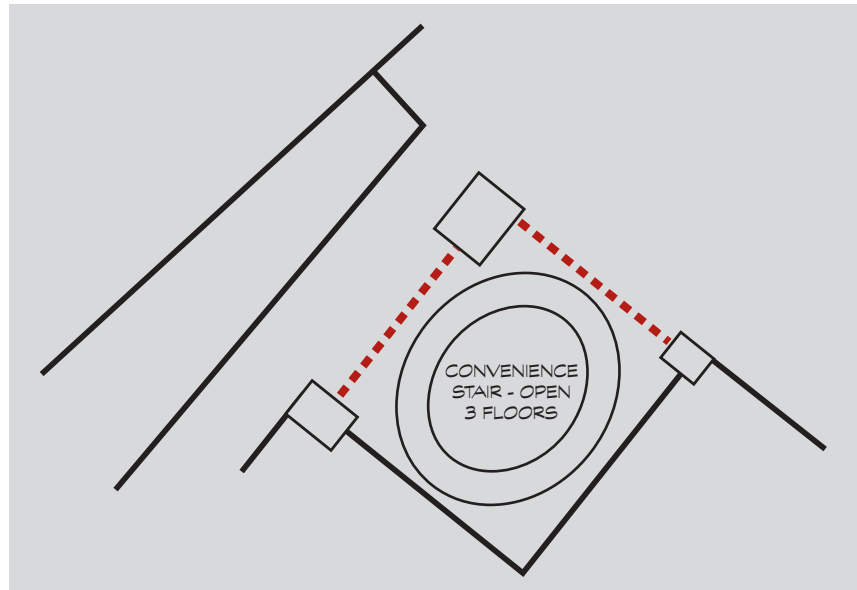
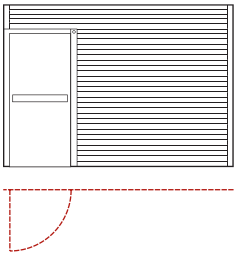

# VERTICAL OPENING SEPARATION

## CASE 2: Side Acting with Complying Egress Door(s)

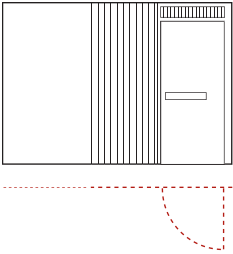

In the second case study a convenience stair within a university learning center is open to each floor it connects during normal school operation. When the building goes into alarm two McKEON 3-hour side acting assemblies, each with a conforming egress swing door and conventional fire exit hardware, combine to provide shaft enclosure protection.



# VERTICAL OPENING SEPARATION

## CASE 3: Extreme Height & Width Side Coiling without Egress

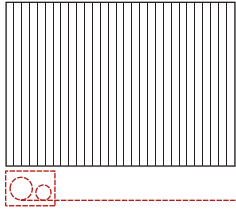

## CASE 4: Side Coiling without Egress

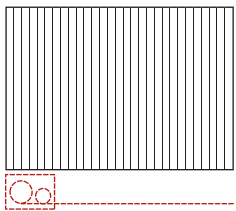

# VERTICAL OPENING SEPARATION

## CASE 5: Deployable Draft Curtains & Closely Spaced Sprinklers

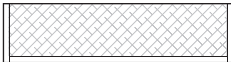

The McKEON D100 draft curtains deploy when there is a fire emergency. During normal hours of building occupancy, unlike conventional fixed draft curtains, the ceiling space around the vertical opening is clear of any obstacles.

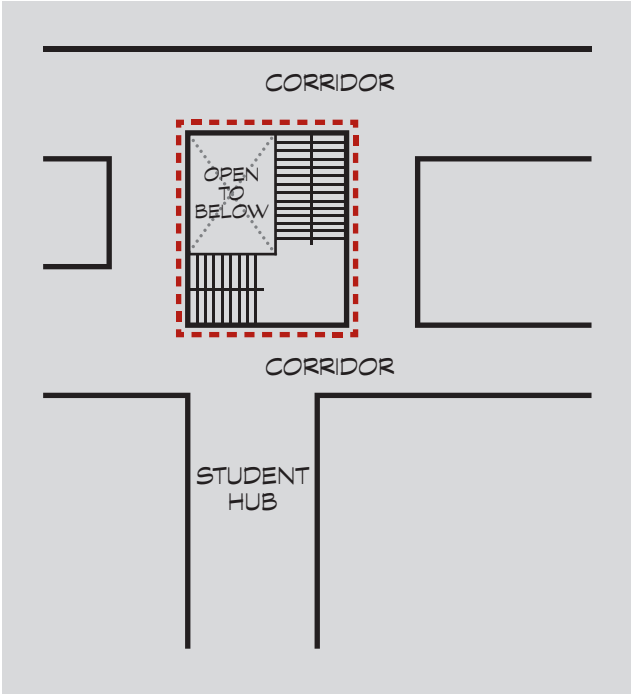



# VERTICAL OPENING SEPARATION

---

## Inquiry Discussion & Questions

These applications, at first glance, would seem to fall under the atrium provisions because there are at least two floors common to each other. Notwithstanding the third floor is separated from the other two, the definition of an atrium is two or more floors interconnected. The purpose for separating floors in order to create only two floors common is to consider the space under the vertical opening provisions of Section 712 in lieu of the atrium provisions in Section 404. Aside from the exit access stairway provisions referenced in Section 712 and detailed in Section 1019, the code includes additional acceptance criteria for two-story openings. Essentially, in other than Groups I-2 and I-3 a floor opening that is not used as one of the applications already listed in Section 1019 or 712.1.9 shall be permitted if it complies with all of the following seven criteria:

1. Does not connect more than two stories.
2. Does not contain a stairway or ramp required by Chapter 10.
3. Does not penetrate a horizontal assembly that separates fire areas or smoke barriers that separate smoke compartments.
4. Is not concealed within the construction of a wall or floor/ceiling assembly.

5. Is not open to a corridor in Group I and R occupancies.
6. Is not open to a corridor on nonsprinklered floors.
7. Is separated from floor openings and air transfer openings serving other floors by construction conforming to require shaft enclosures. (712.1.9)

The following questions may be helpful:

- Do you have clients who wish to occupy multiple floors with a vertical common area connecting all floors?
- Can I show you how interconnecting unenclosed stairs can be incorporated into the design without creating shaft enclosures or complying with atrium provisions?
- Have you been concerned attempting vertical space separation avoiding the closed-in shaft appearance?
- Did you know there is technology available to offer a wide-span opening protective to separate vertical spaces that can also serve as the required exit from unenclosed stairways?

### Notes:

---

---

---

---

---

---

## VERTICAL OPENING SEPARATION

# Vertical Openings – Escalator

Sections 712.1.3

An escalator provides convenient movement for building occupants communicating multiple floors. However, escalators are typically not a part of the required means of egress.

### Fire & Life Safety Concerns

Openings through floors allow fire – or the products of fire (smoke, heat and hot toxic gases) – to spread to other floors. Enclosing these spaces in rated shaft enclosures is certainly the most proficient method of mitigating fire and smoke migration between floors. However, the code incorporates optional provisions as exceptions to the completely sealed vertical shaft.

### Code Requirements

The following exceptions are allowed in lieu of creating a shaft:

Escalators must be enclosed unless the design incorporates the following requirements: (712.1.2)

First, an automatic sprinkler system must be installed throughout the entire building and, secondly an escalator must NOT be in a portion of the means of egress system. If both of these issues are satisfied then the following criteria must be met:

1. The area of the floor opening between stories does not exceed twice the horizontal area of the escalator. (712.1.3.1)
2. The opening is protected by a draft curtain and closely spaced sprinklers in accordance with NFPA 13. (712.1.3.1)
3. In other than Groups B and M, this application is limited to openings that do not connect more than four stories. (712.1.3.1)

# VERTICAL OPENING SEPARATION

## Design Solutions

### CASE 1: L-Shape Horizontal Shutter

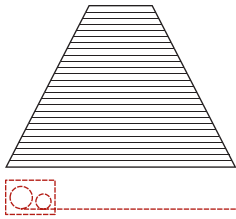

While a parking garage doesn't require an aesthetically pleasing solution, from a life safety perspective the need for fire and smoke protection is the same. A 2-hour rated horizontal shutter satisfies both the basic requirement of opening protection and enclosure of the escalator.

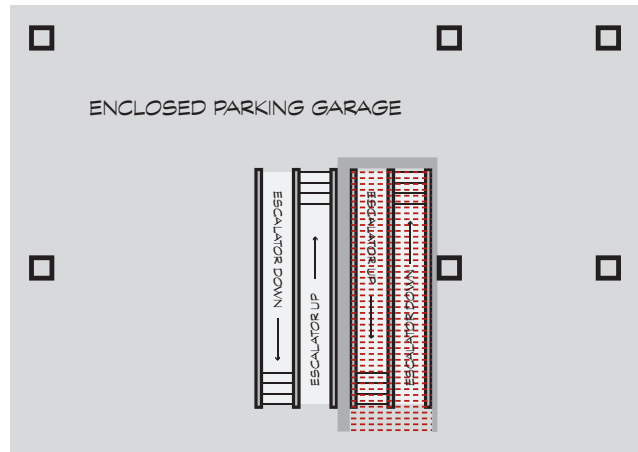

# VERTICAL OPENING SEPARATION

## CASE 2: L-Shape Horizontal Shutter

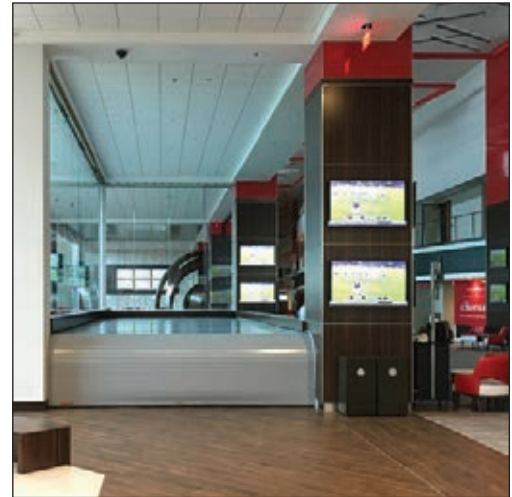
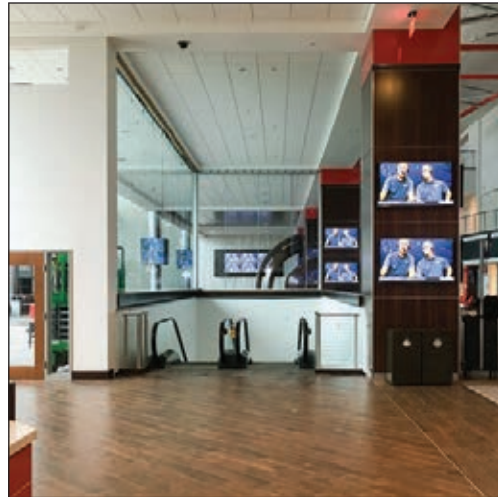
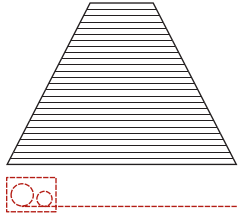

## CASE 3: Deployable Draft Curtains & Closely Spaced Sprinklers

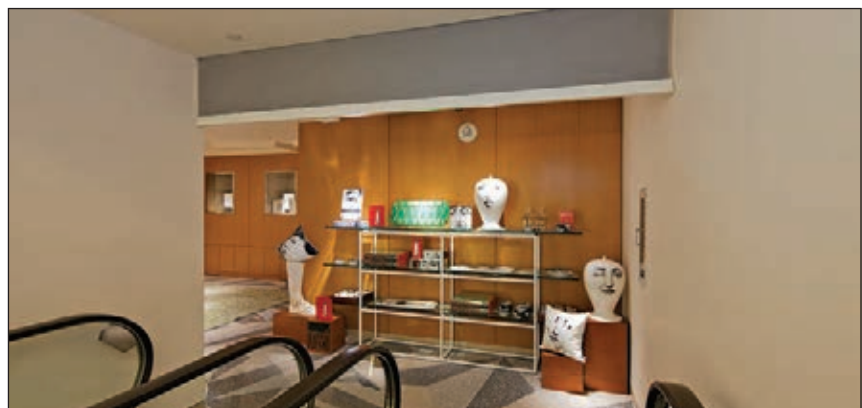

# VERTICAL OPENING SEPARATION

---

## Inquiry Discussion & Questions

Escalators, whether in high-profile locations or low-profile parking garages, cannot be limited to the design criteria as stated above and maintain the desired ambiance of the space.

The following questions may be helpful:

- Would you like to use the escalator as a required exit?
- Have you considered the cost difference between a shaft enclosure and the open escalator design requirements?
- Have you considered wide-span opening protectives as an alternative to conventional swing doors in shaft enclosure walls?

**Notes:**

---

---

---

---

---

---

---

---

---

---

---

---

---

---

---

---

---

---

---

---

---

---

---

---

---

# VERTICAL OPENING SEPARATION

## Interior Exit Stairways

### Section 1023

Exit enclosures extend vertically through the interior of multi-story buildings in order to ensure timely and safe evacuation of occupants during an emergency. These enclosures include exit stairs and exit ramps.

#### Fire & Life Safety Concerns

Because exit enclosures penetrate horizontal floor and ceiling assemblies, fire, heat, smoke and toxic gases can potentially penetrate into building spaces at each floor level. Therefore, enclosures become critical barriers of protection for building occupants. The protected enclosure will be a non-contaminated exit path for at least one hour in buildings less than four stories and two hours in buildings four stories or more.

#### Code Requirements

1. Interior exit stairways shall be enclosed with fire barriers in accordance with Section 707. (1023.2)
2. Exit enclosures in buildings connecting four stories or more shall be rated at 2 hours; less than four stories at 1 hour. (1023.2)
3. Openings and penetrations shall be rated in accordance with Section 716. (1023.4)

# VERTICAL OPENING SEPARATION

## Design Solutions

### CASE 1: Side Coiling with Complying Swing Egress Door(s)

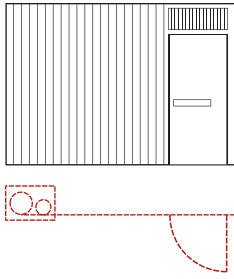

An absence of stacking space dictated use of a unique McKEON product to seal this exit enclosure. The side coiling assembly requires a small box-like space, projecting the 3-hour steel curtain with conventional egress door

along a very narrow pocket entry point and header slot path. When deployed, complete compliance with shaft enclosure opening protective requirements is achieved.

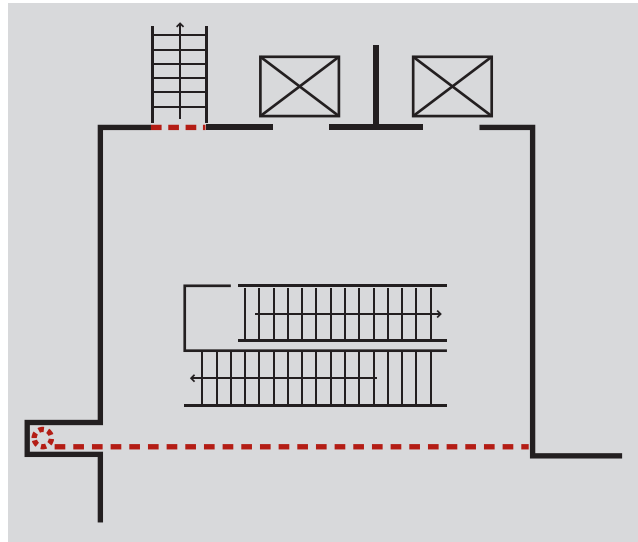

# VERTICAL OPENING SEPARATION

## CASE 2: Side Coiling with Egress

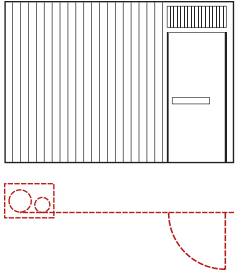

A fixed swing door within the parameters of a lengthy side coiling 3-hour assembly provides a simple resolve in a multi-floor challenge of vertical separation and egress.

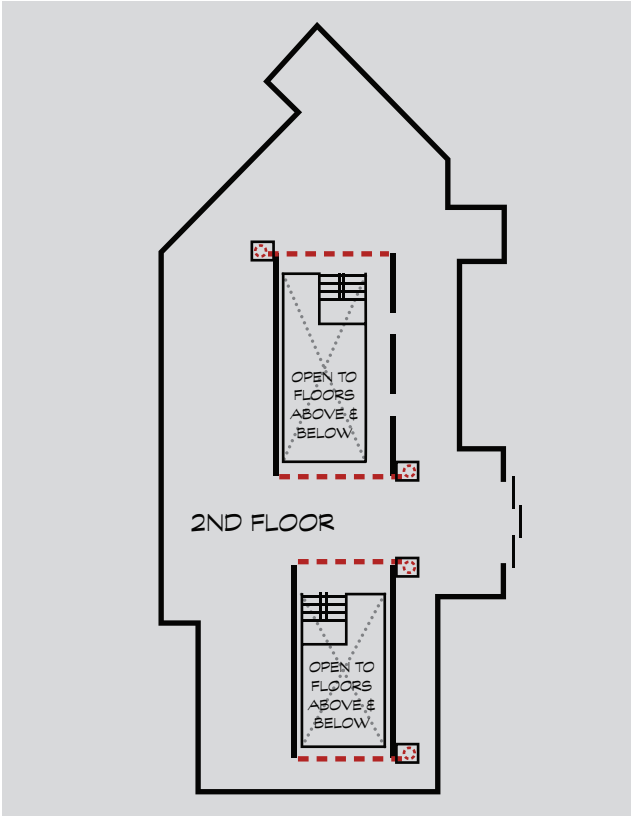



# VERTICAL OPENING SEPARATION

## CASE 3: Vertical Coiling without Egress

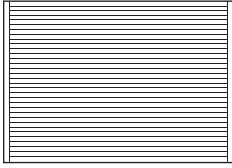

Shaft enclosures that protect a required means of egress are extremely critical to the life safety of building occupants. From a design perspective it is often challenging to incorporate opening protectives in hi-profile open spaces. This extreme width vertical coiling assembly fits narrow header lines, has inconspicuous side guides, and deploys with adequate separation only when the building goes into alarm.

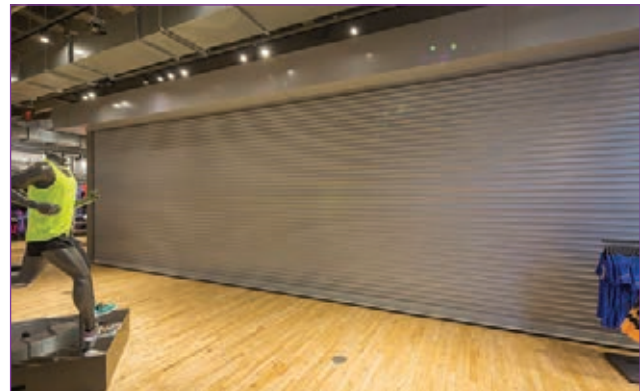
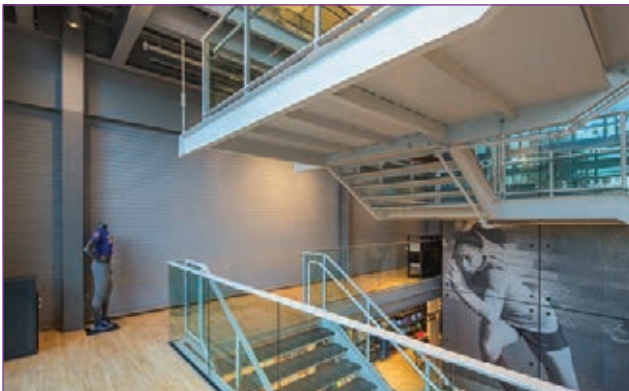
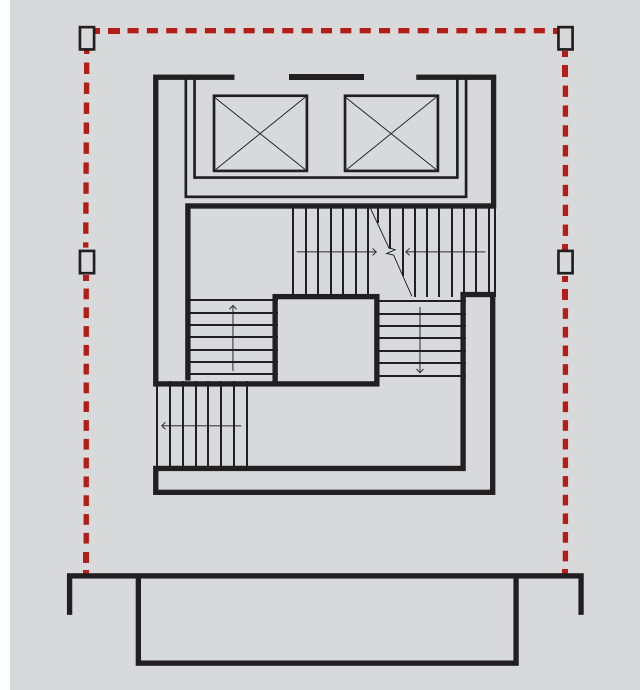

# VERTICAL OPENING SEPARATION

---

## Inquiry Discussion & Questions

Required exit stairs in vertical shaft enclosures ensure building occupant safe evacuation. Historically the designs of openings at the level of exit discharge have been limited to conventional side-hinged swinging doors. The acceptance of the McKEON products as both wide-span opening protectives as well as a complying egress doors provide the designer flexibility without compromising code compliance.

The following questions may be helpful:

- Do you find building owners and maintenance groups struggling with door swing and maintenance on door hardware in high-traffic spaces?

- Do you seek an open and spacious appearance at the landing area of vertical stair enclosures?
- Would you like to use a required vertical exit stair shaft as an aesthetically pleasing communicating stair by opening the enclosure area at each floor?

**Notes:**

---

---

---

---

---

---

---

---

---

---

---

---

---

---

---

---

---

---

---

---

---

---

---

---

# VERTICAL OPENING SEPARATION

## Atriums

### Section 404

An atrium is a floor opening, or a series of floor openings, that connects the environment of adjacent stories. By code definition an atrium is a space within a building that extends vertically and connects two or more stories. Atriums are designed to provide open and spacious vertical areas common with other building elements.

#### Fire & Life Safety Concerns

Unprotected vertical openings are often cited as the factor responsible for fire spread in incidents involving fire fatalities and/or extensive property damage. Section 404 addresses the need for protection of these specific building features in lieu of providing a complete floor and/or vertical shaft separation. In simple terms, the atrium provisions are extremely restrictive because a complying atrium is a shaft enclosure.

#### Code Requirements

Vertical common areas that comprise an atrium are not considered unprotected, rather the atrium is considered a protected space by means other than a conventional “walled-in” shaft enclosure. Listed below are the specific provisions allowing atriums to be open and spacious yet considered a conforming shaft enclosure:

1. The atrium floor area is permitted to be used only for low-hazard uses unless the individual space is provided with an automatic sprinkler system. (*Section 404.2*)
2. An approved automatic sprinkler system shall be installed throughout the entire building. (*Section 404.3*)
3. A fire alarm system shall be provided. (*Section 404.4*)
4. Engineered smoke control system – this system shall be installed in accordance with Section 909 when the atrium space exceeds more than two floors. (*Section 404.5*)
5. Atrium spaces shall be separated from adjacent spaces by 1-hour fire barrier construction unless at least one of the following exceptions are met: (*Section 404.6*)
  - A glass wall forming a smoke partition where automatic sprinklers are spaced 6 feet or less along both sides of the separation wall, or on the room side only if there is not a walkway

# VERTICAL OPENING SEPARATION

on the atrium side, and between 4 and 12 inches away from the glass ... the entire glass surface must be wet upon activation ... the glass shall be mounted in a gasketed frame ... (404.6)

- Provide a glass block wall assembly in accordance with Section 2110 ... (404.6)
- Fire barrier walls are not required between the atrium and adjoining spaces where the atrium is not required to have a smoke control system. (404.6)
- The adjacent spaces of any three floors of the atrium shall not be required to be separated from the atrium ... if included in the smoke control calcs. (404.6)
- Smoke control equipment must be on a standby power system. (Section 404.7)
- The atrium interior finish of walls and ceilings must be not less than Class B. (404.8)
- With the exception of the lowest atrium level, the required means of egress in the exit access system travel distance shall not exceed 200 feet. (404.9)

## Design Solutions

The use of deployable wide-span opening protectives in vertical atrium spaces, both vertically and horizontally, can significantly reduce construction and maintenance costs.

### CASE 1: Side Acting with Complying Swing Egress Door(s)

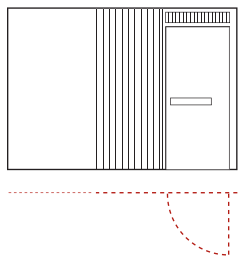

This unique case study features another McKEON product for resolving multiple design/code challenges simultaneously. The lower floor travel path is a required design feature for egress and – combined

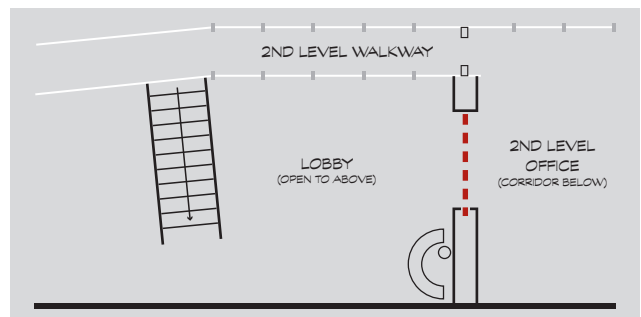

with the non-rated second floor overlook – is certainly a very creative solution. However, without the side acting, extreme height and egress conforming McKEON assembly this would not be possible!

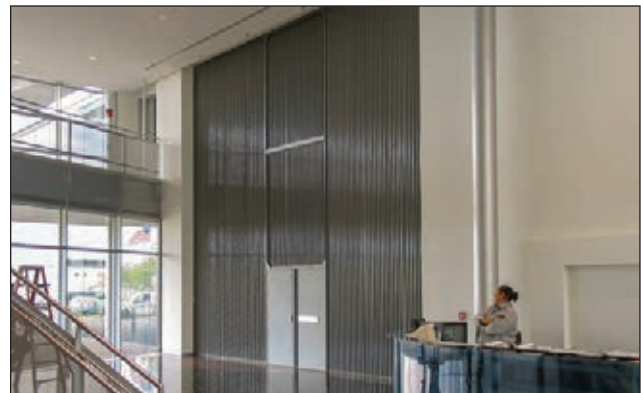

# VERTICAL OPENING SEPARATION

## CASE 2: Horizontal (Floor) Shutter

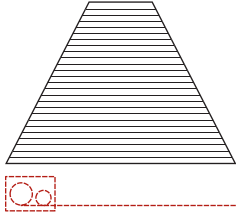

In this case study the atrium space is essentially converted to a vertical compartment separation using the McKEON horizontal shutter. Please refer to the “vertical compartmentation” case studies at the end of this section for more information. Note the absence of any smoke evacuation systems!

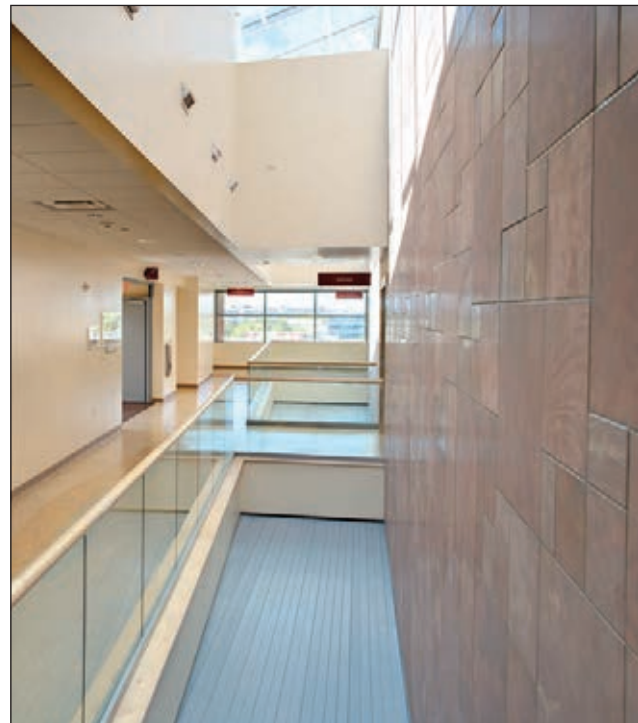
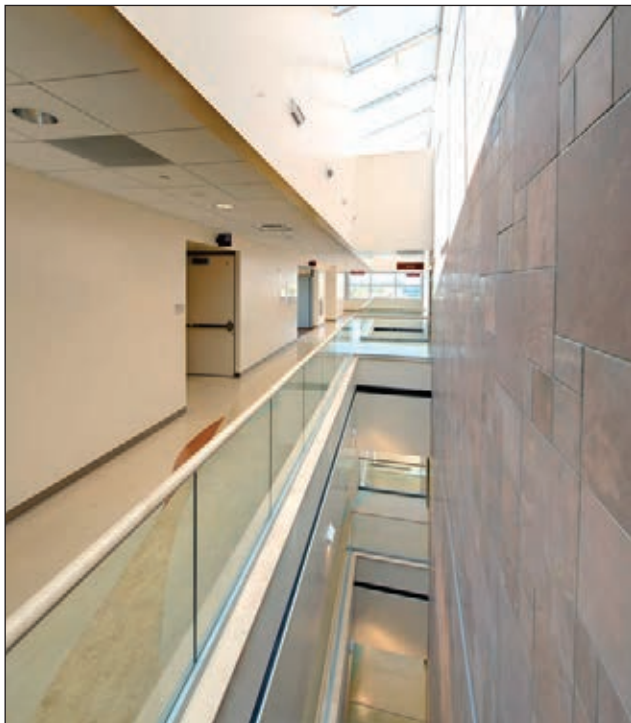
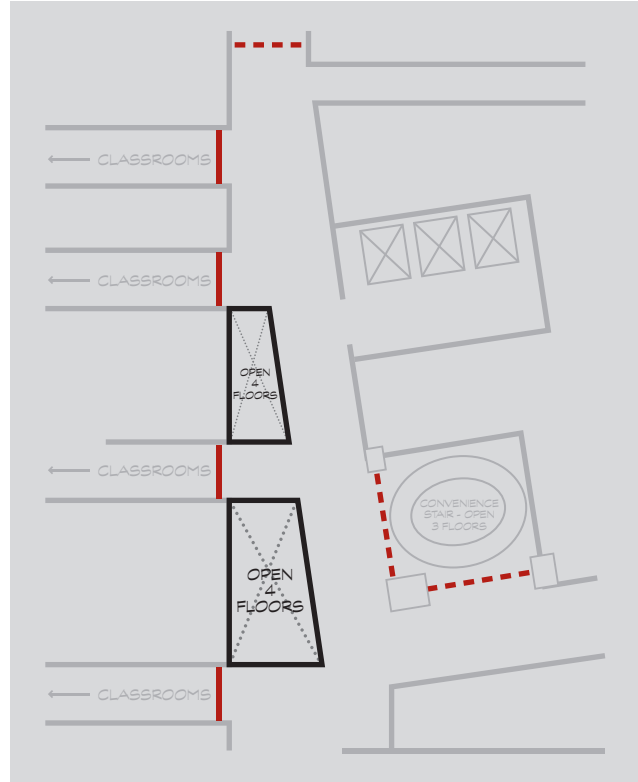

# VERTICAL OPENING SEPARATION

## CASE 3: Side Coiling without Egress

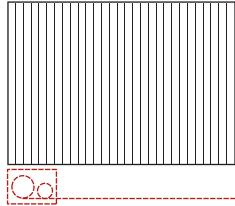

Even though this design incorporates an escalator, Item #2.1 under Exception #2 can only be applied if the area of the floor opening between stories does not exceed twice the horizontal projected area of the escalator. Since the area in this vertical open space is greater, the next option is to explore the possibility of creating a vertical shaft enclosure allowing no more than two floors common or interconnecting. With a 2.25" head-track design, 3-hour fire listing and unlimited width capacity, McKEON easily solved the problem with a triple curve, non-floor track 140' bi-part opening protective.

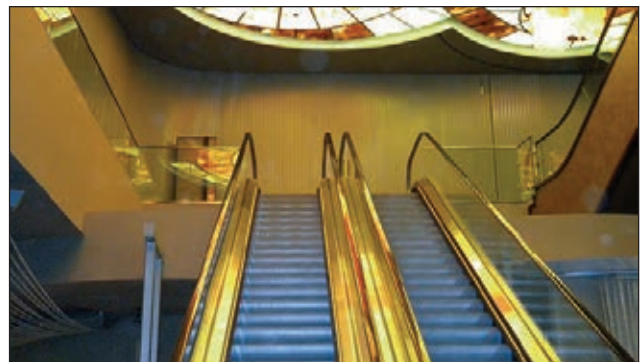
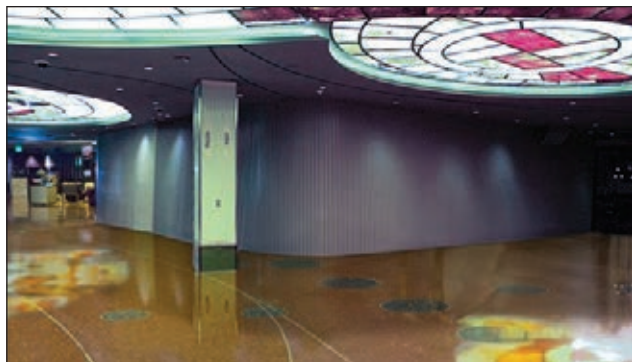
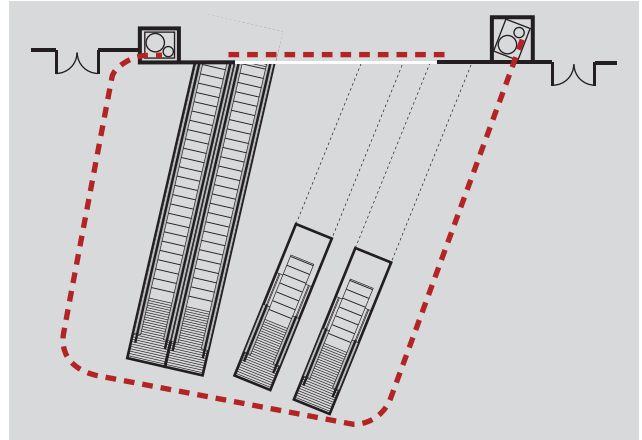



# VERTICAL OPENING SEPARATION

# Vertical Compartmentation

Combined Code Principles from Chapters 4, 7 & 10

Protecting openings that connect multiple floors are currently addressed by the building and fire codes by way of vertical type shaft enclosures, atrium provisions or requirements relative to small floor or roof hatch type openings. In the following case studies a new technology and product application will be discussed wherein vertical compartments can be created separating any number of stories from each other. This will be accomplished by coordinating in one application the intent of the provisions found in both atrium and shaft enclosure requirements.

## Fire & Life Safety Concerns

As stated in the atrium case studies, vertical spaces that are interconnected and common with each other allow heat, smoke, and hot/toxic gases to migrate throughout an entire structure.

## Code Requirements

Currently the code examines vertical opening conditions in Section 712, Vertical Openings and Section 713, Shaft Enclosures. In earlier editions of the code, all vertical openings were considered under the shaft enclosure provisions only. The older Section 708.2, Shaft Enclosure included 16 exceptions, or different ways of creating vertical spaces as shaft enclosures. The 2012 edition created a new Section 712 titled Vertical Openings, wherein the old 16 exceptions in Section 708.2 were moved and edited. These items, originally written as exceptions to the shaft requirements, became stand-alone provisions defining vertical opening conditions, rather than exceptions or re-writes to strict shaft enclosure requirements. Although the fundamental content did not change, placing the shaft provisions under the title of Vertical Openings significantly affects one's perspective regarding their intended purpose. Perhaps this paradigm shift, from shaft enclosure provisions to vertical opening provisions is, in fact, a monumental shift not seen in many years! However, none of these accepted methods specifically address the exclusive use of horizontal shutters to eliminate a vertical condition. Unless an escalator opening is being protected or a door-hatch assembly is used to protect small structural openings in floors and roof assemblies, the code is vague regarding protection of vertical openings in the creation of vertical compartments.



# VERTICAL OPENING SEPARATION

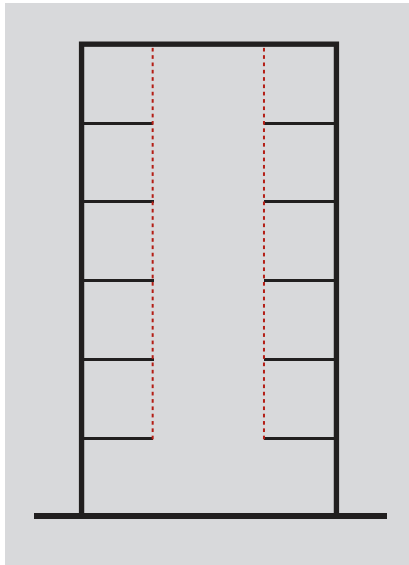

Figure 1

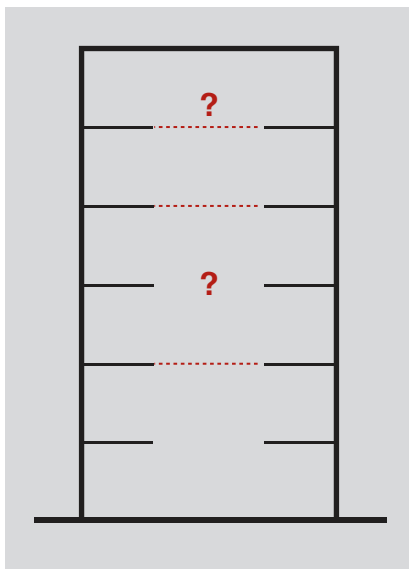

Figure 2

**Figure 1**, shown at the left, addresses a vertical opening condition complying with Sections 712 and 713 requirements to seal the space. Note, the atrium requirements are designed to essentially replicate this condition. By definition an atrium is a shaft enclosure.

Within the current provisions set forth in Sections 712 and 713, the basic core and shell of this structure is still going to be a protected shaft. For example as shown in **Figure 2**, when one uses certain provisions of Section 404, by way of exception two floors can be common and the smoke evacuation can be eliminated from those two floors, while all the other vertical separation or atrium provisions are retained. Yet in other provisions of Sections 712 and 1019 the incorporation of an exit access stairway allows two unprotected floors common. In fact, the 2015 and 2018 editions separate exit access stairs into their own Section 1019 and in definitions in Section 202 declares exit access stairways as “a stairway within the exit access portion of the means of egress system.”

The question is, is it possible to eliminate the “vertical” open condition “horizontally” without a stair by protecting the vertical opening in the spirit of compartmentation since a structural floor was never in the original design as shown in **Figure 2**, and if so how many floors can be common? Exact code language is not found, however if the vertical opening is eliminated horizontally with a rated and hose-stream tested assembly, has the potential for migration of smoke, heat and hot/toxic gases been mitigated? The answer is a resounding yes with one important caveat. Since this configuration is defining a 2-story atrium it is critical to meet the atrium separation requirements. Section 404.6, Enclosure of atriums, specifically requires that atrium spaces be separated from adjacent spaces by 1-hour construction both vertically and horizontally. Therefore, defining atriums as 2-story spaces can be achieved with 1-hour construction only. In other words, non-hose stream tested assemblies that are limited to 20-minute ratings under UL 10B, 10C or 10D cannot be used to define an atrium in either the vertical or horizontal orientation.

# VERTICAL OPENING SEPARATION

## Design Solutions

### CASE 1: Horizontal (Floor) Shutter

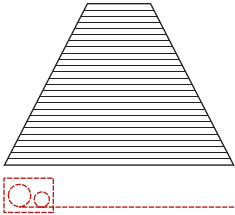

UL 10B 2-hour & UL 1784  
“S” labeled, hose stream  
tested assembly.

# VERTICAL OPENING SEPARATION

## Case 2: Horizontal (Floor) Shutter

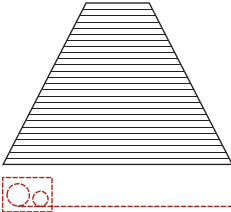

UL 10B 2-hour & UL 1784  
“S” labeled, hose stream  
tested assembly.



# VERTICAL OPENING SEPARATION

## CASE 3: Horizontal (Floor) Shutter

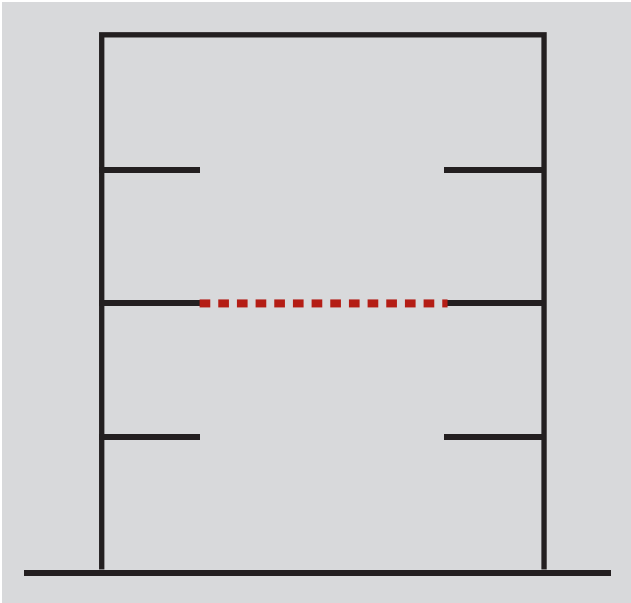
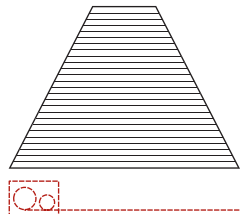

UL 10B 2-hour & UL 1784  
"S" labeled, hose stream  
tested assembly.



# VERTICAL OPENING SEPARATION

## CASE 4: Horizontal (Floor) Shutter

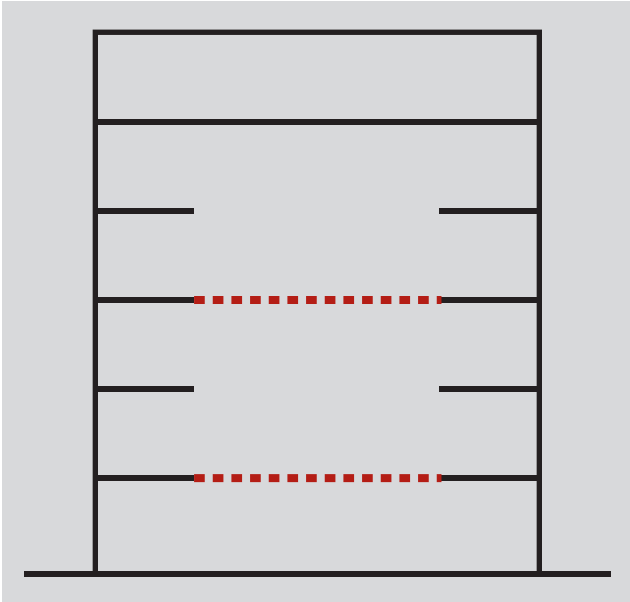
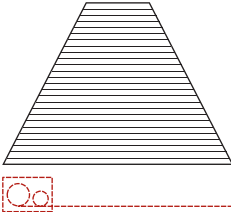

UL 10B 2-hour & UL 1784  
"S" labeled, hose stream  
tested assembly.



# 4 | Occupancy Separation

**Fundamental Guidelines**

**Mixed Occupancy – Accessory Use**

**Mixed Occupancy Use –  
Non-Separated vs. Separated**

# OCCUPANCY SEPARATION

# Fundamental Guidelines

## Table 508

**Most buildings are designed for multiple uses that will typically result in more than one occupancy classification. The code provides three basic options for mixed occupancies in Section 508:**

- 1. Accessory occupancies: Section 508.2**
- 2. Non-separated occupancies: Section 508.3**
- 3. Separated occupancies: Section 508.4**

Chapter 3 of the building code specifically classifies a building according to its use and occupancy. The level of fire hazard varies with specific uses and occupancies in a building. However, this level of hazard and its potential affect on the building occupants is determined not only by the use and occupancy classification by construction type, height and area size, but also the use of passive and active fire protection systems. Chapter 5 combines fire-resistance levels, construction types and occupancy types to determine size and height limitations as well as separation requirements.

Increased fire resistance of the structural members of the building along with increased active and passive fire protection systems permits greater height and area allowances. Notwithstanding, the use and occupancy of the structure will become a determining factor regarding the extent of separation and compartmentation required. For example, a “B” (business occupancy) is allowed occupant load floor area to be calculated at 100 gross sq. ft. per occupant. However, a group “I-2” occupancy (hospital) which is a similar occupant load as far as quantity of people, is required to be calculated at 240 gross sq. ft. per occupant, more than double that of a “B” occupancy. The difference between these requirements is the use of the facility. Occupants in a hospital need better protection for a greater amount of time because they are non-ambulatory and most are dependent upon others for mobility or even life support. Therefore, the fire and life safety requirements designed to help protect building occupants are very different for each of these occupancies.

When buildings are designed as mixed occupancies there is a concern because basic fire and life safety requirements are being

# OCCUPANCY SEPARATION

---

mixed within the same structure. Three basic options to eliminate confusion and ensure building occupant safety are outlined as follows:

## **Accessory Occupancy:**

1. Accessory occupancies are those which are different from the main occupancy but ancillary to or a portion thereof. *(508.2)*
2. Aggregate accessory occupancies shall not occupy more than 10% of the area of the story. *(508.2.3)*
3. Aggregate accessory occupancies shall not exceed the tabular values in Table 506.2 without height and area increases. *(508.2.3)*
4. Accessory occupancies shall be individually classified in accordance with Section 302.1. *(508.2.1)*

## **Non-Separated Use:**

To consider spaces under the Non-Separated Use requirements, the following must be met allowing NO separation between occupancies:

1. Each occupancy use shall be individually classified. *(508.3.1)*
2. Code requirements shall apply to each portion of the building based upon the occupancy classification of the space under consideration. *(508.3.1)*
3. The most restrictive applicable provisions of Section 403 and Chapter 9 shall apply to the building or portion thereof in which the non-separated occupancies are located, Section 403 in hi-rise and Chapter 9 in all others.

4. The allowable building area and height of the building or portion thereof shall be based on the most restrictive allowances for the occupancy groups under consideration for the type of construction of the building in accordance with Section 503.1. *(508.3.2)*

## **Separated Use:**

The following requirements under the provisions of Separated Occupancies will bring these spaces into compliance without compromising design if separated with fire barrier walls according to Table 508.4:

1. Separated occupancies shall be classified in accordance with Section 302.1. *(508.4.1)*
2. Each separated space shall comply with the code based upon the occupancy classification of that portion of the building. *(508.4.1)*
3. In each story, the building area shall be such that the sum of the ratios of the actual building area of each separated occupancy divided by the allowable building area of each separated occupancy shall not exceed 1. *(508.4.2)*
4. Each separated occupancy shall comply with the building height limitations based on the type of construction of the building in accordance with Section 503.1. *(508.4.3)*



## OCCUPANCY SEPARATION

# Mixed Occupancy – Accessory Use

## Section 508.2

Post grade 12 educational occupancies are typically classified as “B” occupancies and usually incorporate mixed occupancies that are often considered accessory – full service kitchens and cafeterias (A-2), assembly areas (A), and dormitories (R-2) occupancies. Even though these spaces are ancillary to and a functional portion of the original larger occupancy they must be separated when they exceed the 10% rule.

### Fire and Life Safety Concerns

In this case study we will examine the potential fire and life safety threats posed due to the use of open flames, combustible gases and solids, and exhaust hood extinguishing systems. These kitchens (A-2) are often common with other areas (B or R-2) in the facility potentially exposing large groups of building occupants to the associated hazards. In these cases and similar situations, where the spaces are greater than 10%, separation is required.

### Code Requirements

Table 508.4 in Chapter 5 provides the requirements for separation of occupancy types. Should an accessory occupancy exceed the 10% rule, this table becomes the determining factor. Since the separation must be a fire barrier wall (508.4.4.1), Table 508.4 requires a 1-hour separation between an “A” and “B” occupancy or “R” and “B” occupancy when the building is fully sprinklered and 2-hour in non-sprinklered buildings.

# OCCUPANCY SEPARATION

## Design Solutions

### CASE 1: Side Acting Accordion with Power-assisted Egress

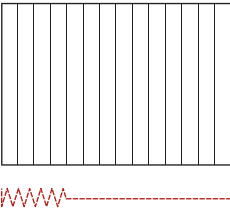

This first case study examines the use of the McKEON Side Acting Accordion fire door. The assembly is hidden from view unless there is a fire when it is activated by the smoke detector. Egress is accomplished by compliance to 1010.1.4.3.

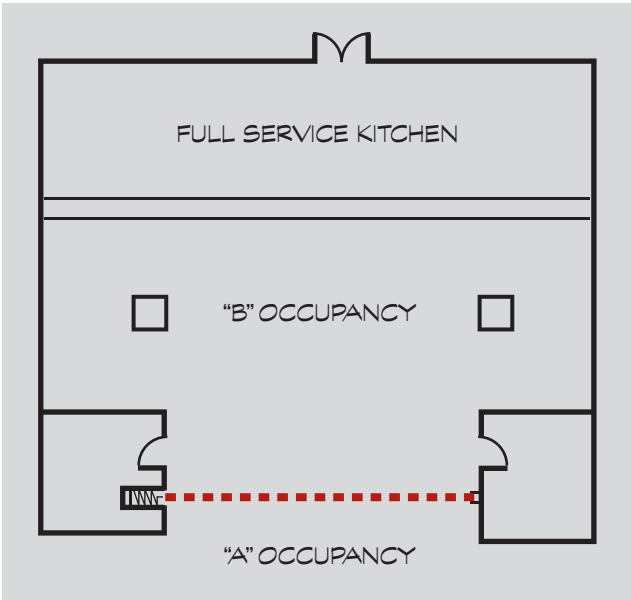

# OCCUPANCY SEPARATION

## CASE 2: Side Coiling without Egress

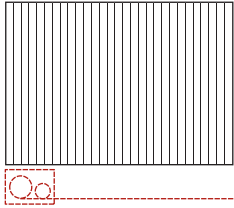

This case study is very similar to the previous application with the exception of an egress requirement. The McKEON side coiler without egress became the most economical solution without compromising life safety.



## CASE 3: Side Coiling with Complying Swing Egress Door(s)

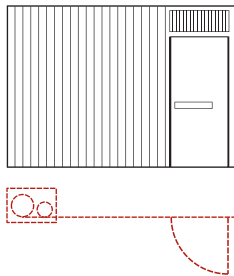

This third case study features a different product under the same code premise, the requirement to separate an "A-3" occupancy (library) from the rest of the "B" occupancy, school. The feature product is the Side Coiling with Conventional Egress Assembly due to limited width of pocket space.

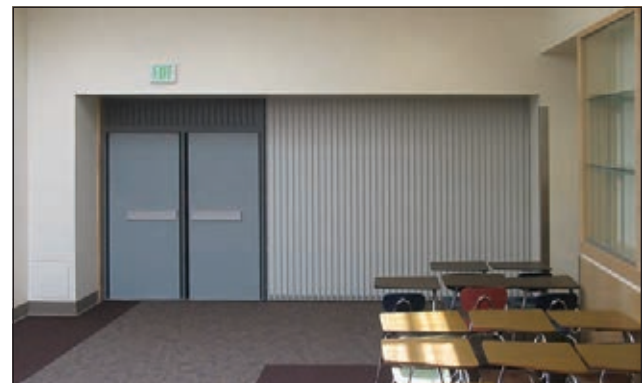
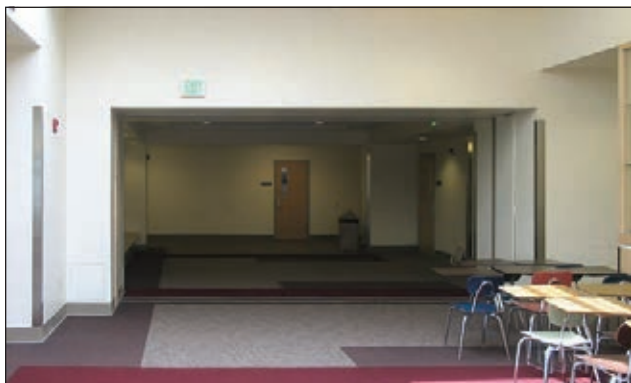
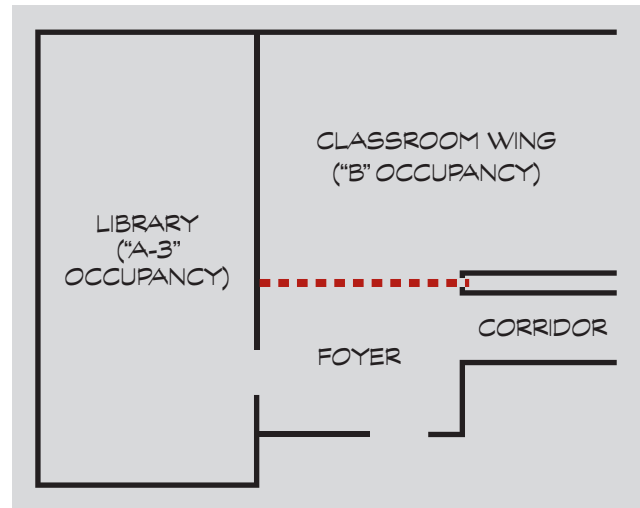



# OCCUPANCY SEPARATION

## Mixed Occupancy Use – Non-Separated vs. Separated

Section 508; Table 508.4

Complying with Table 508.4 and providing fire barrier walls to separate occupancies can be limiting to the design. Also, using non-separated provisions to eliminate restrictive fire barrier walls becomes extremely costly due to added fire and life safety requirements that affect the entire structure.

### Fire & Life Safety Concerns

Building structures are classified based on their occupancy and use. The purpose for classifying structures is to configure optimum safety requirements commensurate to the need as dictated by each individual use. These areas of concern are general building limitations, means of egress, fire protection systems and interior finishes. The challenge comes when buildings contain rooms or spaces that are different than the original building occupancy classification thereby creating a mixed use or mixed occupancy structure.

### Code Requirements

In this case study the Conference/Training room is 1,188 square feet with an occupant load of 79. It is classified as an A-3 occupancy located in a 5-story Group B office building of Type IIIA construction. The conference room is classified as an A-3 because it is used for gathering a large number of people for assembly purposes (Section 303.1). It cannot be considered an accessory space because it exceeds both occupant load and area square footage of the accessory use exceptions.

First, let's look at the requirements imposed if we attempt to eliminate all separations as indicated in Table 508.4, in other words non-separated use.

Non-Separated Use:

1. Each use shall be individually classified. (508.3.1)
  - The entire building is classified as a "B" occupancy. The

- space under consideration (Conference/ Training room) is an A-3 occupancy.
2. The allowable building area and height of the building or portion thereof shall be based on the most restrictive allowances for the occupancy groups under consideration ... (508.3.2)
  3. The most restrictive applicable provisions of Section 403 and Chapter 9 shall apply to the entire building or portion thereof. (508.3.1)
    - Section 403 encompasses the requirements for hi-rise construction and Chapter 9 include the provisions for fire protection systems. In other words, the building will have to incorporate the most protective and restrictive requirements of these chapters. For example:
      - Standpipe system (403.4.3)
      - Smoke detection (403.4.1)
      - Fire Alarm systems (403.4.2)
      - Emergency voice/alarm communication system (403.4.4)
      - Fire command (403.4.6)
      - Smoke removal (403.4.7)
      - Emergency responder radio coverage (403.4.5)
      - Standby power (403.4.8)
      - Emergency power systems (403.4.8.4)
  4. The allowable height and area of the building or portion thereof shall be based on the MOST RESTRICTIVE allowances for the occupancy group under consideration for the types of construction of the building in accordance with Section 503.1. (508.3.2)
    - The height and area allowances for this requirement would not allow the building to be five stories. Most likely only three at best.

# OCCUPANCY SEPARATION

## Design Solutions

### CASE 1: Vertical Coiling with Complying Swing Egress Door(s)

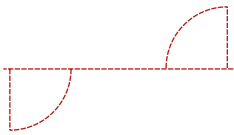
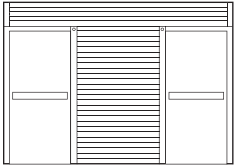

The use of wide span opening protectives enables occupancy separation without compromising open and spacious design. In this case study a simple deployable separation prevents the overall structure from being subject to the most restrictive provisions of non-separated use.

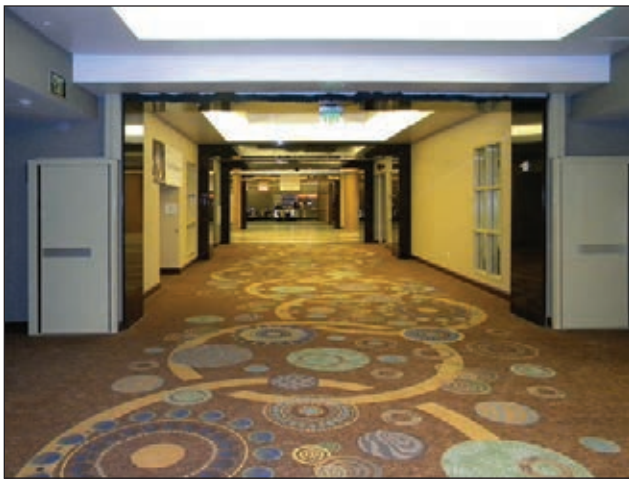
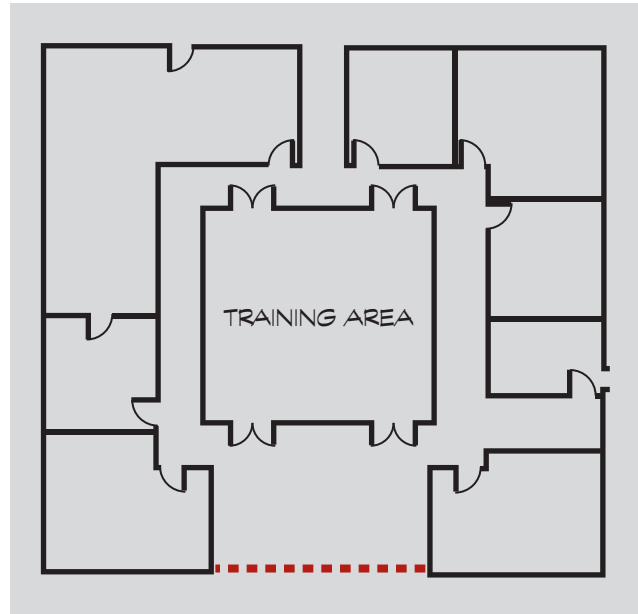

# OCCUPANCY SEPARATION

## CASE 2: Side Acting with Complying Swing Egress Door(s)

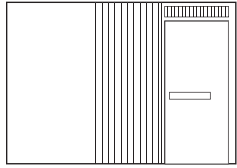

This case study is a text book example of occupancy separation, but is very unique in product application problem-solving from an architectural perspective. Pocket space was limited in width, but not depth, and headroom was extremely limited. Given the ambiance of the space, conventional

swing doors on magnetic hold-opens were not an option. McKEON provided the S7000 series which requires only a 7" pocket width and no more than a 2 1/4" reveal in the ceiling for the head track. With patented side acting technology the entire assembly, incorporating four conventional swing doors, fits into a narrow space parallel to the fire barrier wall. Upon command of the smoke detector the 3-hour assembly slides into place providing occupancy separation and conforming egress.

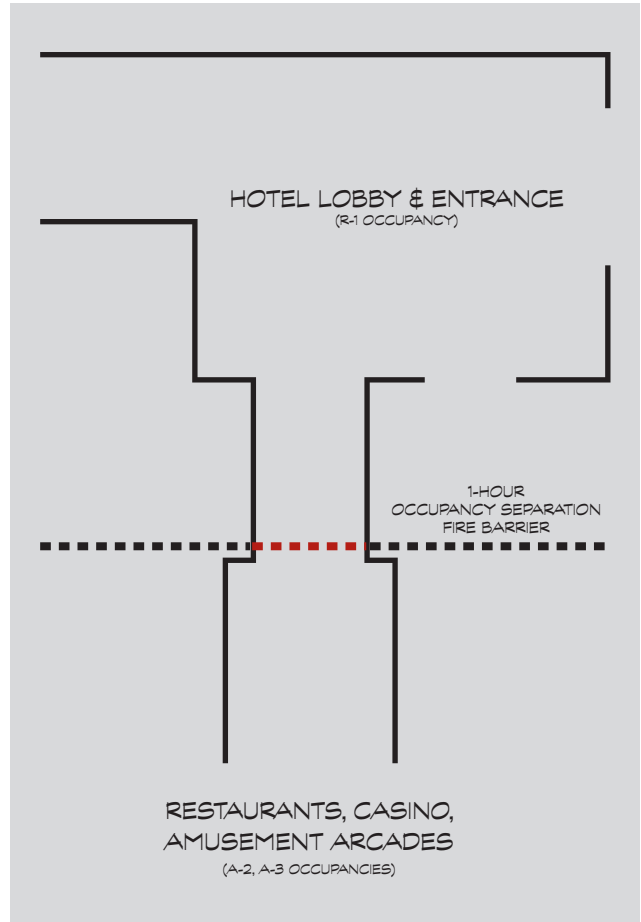



# OCCUPANCY SEPARATION

## CASE 3: Vertical Coiling with Complying Swing Egress Door(s) & Vertical Coiling without Egress

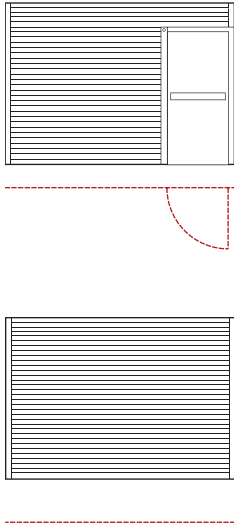

In this case study McKEON offers a solution to a difficult challenge by providing two different products within the same space. A combination of six fire-rated vertical rolling shutters installed on a diagonal path of travel and one vertical coiling assembly with conventional egress for exiting from the space. This solution preserves the beauty of the space without compromising mixed occupancy separation requirements.

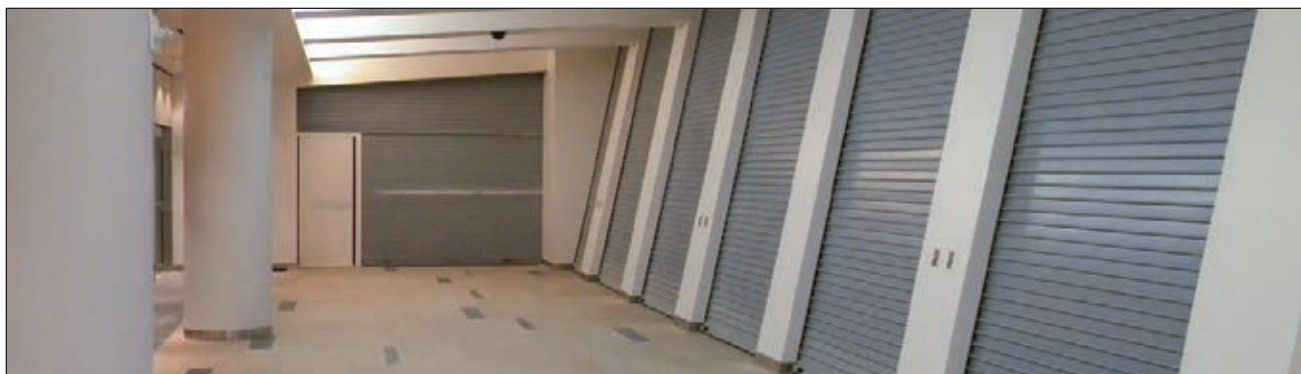
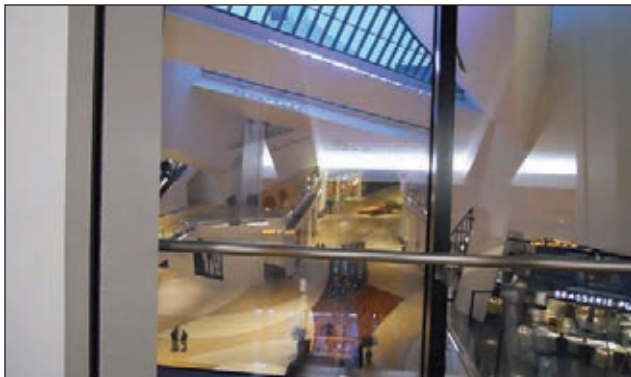
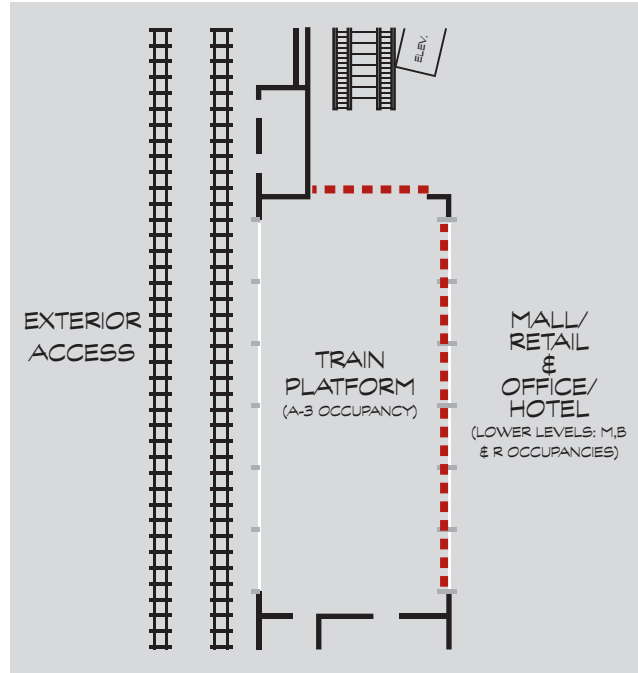

# OCCUPANCY SEPARATION

## CASE 4: Vertical Acting with Complying Swing Egress Door(s)

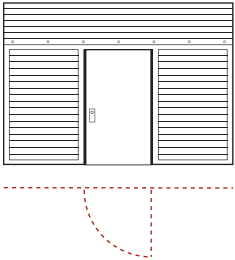

This application illustrates McKEON's capacity to provide 3-hour separation, conforming to a large occupant load exit width without occupying side stacking space. Deploying only in case of fire or emergency, both egress and fire separation requirements are satisfied without compromising design.

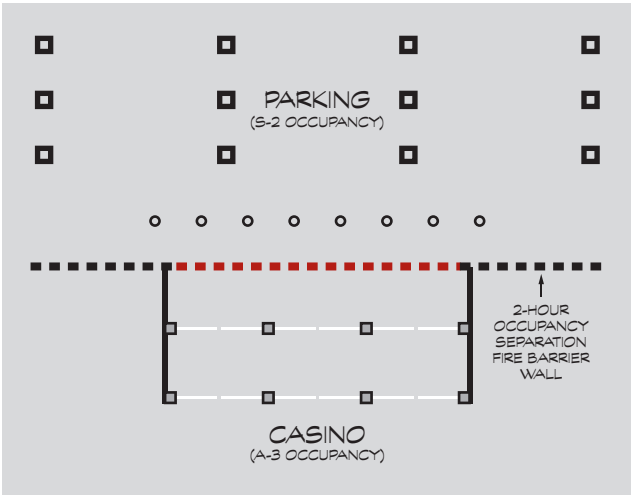





# 5 | Area Separation

Allowable Area

# AREA SEPARATION

## Allowable Area

Section 706; Tables 504.3, 504.4, 506.2

The allowable height and area of a building structure is determined largely by two basic factors; first, the combustibility of its structural materials and second, occupancy type or use and purpose of the building. When a building design exceeds the established values, the intent of the code is to create another separate building structure to incorporate the increase. Since this is not always desirable, the code will allow interior fire walls to serve as separations sufficient to consider each space a separate structure within the tabular value allowance. In essence multiple compliant buildings can be created within the same structure and under a common roof.

### Fire & Life Safety Concerns

Building height and area are calculated to accommodate three fundamentals principles in fire and life safety. First, the structural elements, rated or non-rated, are intended to maintain structural integrity during fire and other life threatening emergencies. This means the greater the protection of the structural elements, the larger the height and area. Second, additional height and area are allowed when active fire suppression systems such as sprinklers are used. Finally, passive redundant elements are used to compartmentalize the area and provide protection for building occupants as they egress the structure. Rated construction protects the structural elements, sprinklers protect the building contents, and egress protects building occupants by removing them from harm's way. All three principles overlap and work together to ensure a building occupant has adequate time to safely exit the structure. The reduction or absence of any of these components can compromise the safety of building occupants and cause property damage.

Another concern is the size of openings allowed in the passive redundant system, particularly in fire walls that are crucial to the area limitations. Opening size limitations are imposed to maintain the integrity of the wall during fire conditions. Opening protectives inherently accommodate strict requirements to adequately protect and maintain the integrity of the openings. The structural integrity of the fire wall must be maintained regardless of the wall opening size or its opening protective. It is critical to remember; the opening protective protecting an opening in a fire wall is not required to conform to structural integrity provisions. The opening protective is protecting the opening – NOT the wall. A fire wall used for area separation is allowed openings and opening protectives, however, a fire wall used as a party wall cannot have openings.

## Code Requirements

1. The above referenced tables of Chapter 5 indicate the tabular height and area allowances for specific building construction types and occupancies.
2. Each portion of a building separated by one or more fire walls shall be considered a separate building. (503.1)
3. Openings in fire walls are subject to the following criteria (706.8):

*Non-sprinklered buildings* – Openings shall not exceed 156 square feet and the aggregate width of openings at any floor shall not exceed 25 percent of the length of the wall.

*Sprinklered buildings* – Openings shall not be limited to 156 square feet and the aggregate width of openings at any floor shall not exceed 25 percent of the length of the wall.

# AREA SEPARATION

## Design Solutions

### CASE 1: Vertical Acting with Complying Swing Egress Door(s)

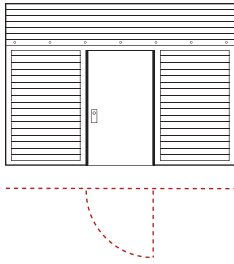

In this application McKEON resolved two significant design code compliance problems without sacrificing wide span open appearance. First, nearly the entire opening was necessary to meet the exit width requirements located in the primary means of egress system in an “A” occupancy. Using the McKEON accordion assembly would not comply because of a) the large distance to be covered and b) the length of time required to open wide enough to allow for immediate egress. Second, there was not sufficient stacking space for any of the McKEON side acting models. However, because headroom was plentiful and large occupant load egress was a necessity, the T5000 series incorporating six egress conventional swings doors, three doors set in each direction to accommodate dual egress, was the perfect fit and the only viable solution.

Using the McKEON accordion assembly would not comply because of a) the large distance to be covered and b) the length of time required to open wide enough to allow for immediate egress. Second, there was not sufficient stacking space for any of the McKEON side acting models. However, because headroom was plentiful and large occupant load egress was a necessity, the T5000 series incorporating six egress conventional swings doors, three doors set in each direction to accommodate dual egress, was the perfect fit and the only viable solution.

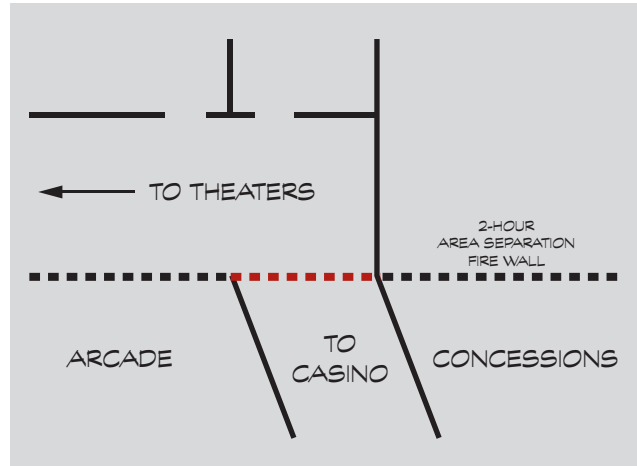

# AREA SEPARATION

## CASE 2: Vertical Coiling without Egress, Vertical Acting with Complying Swing Egress Door(s) & Side Acting without Egress

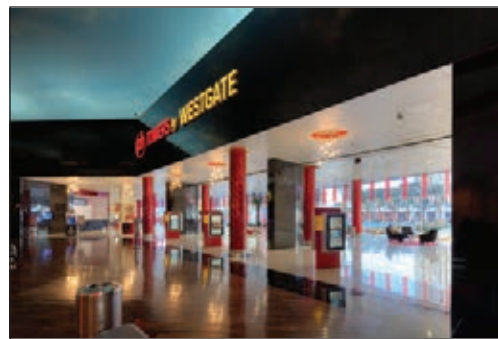
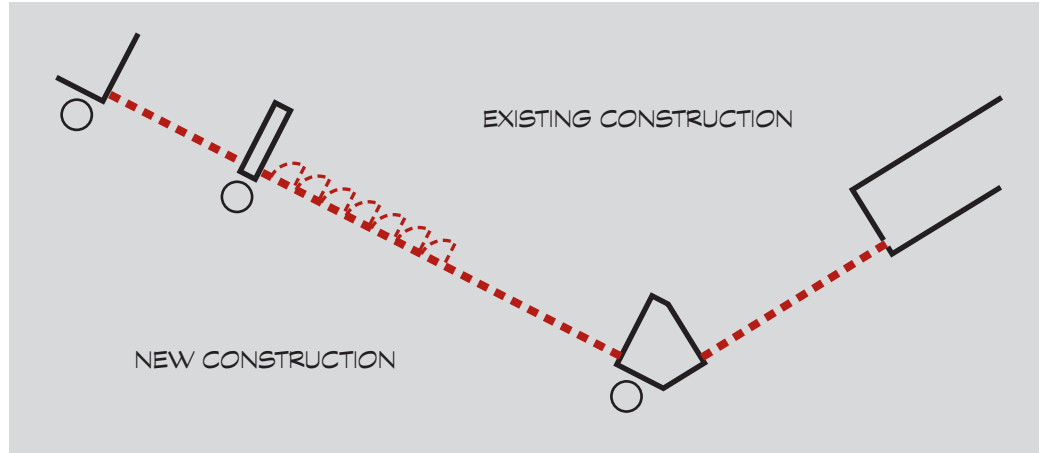
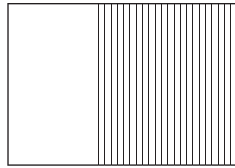
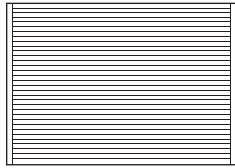







# 6 | Corridor Separation

Corridor Separation – Healthcare

## CORRIDOR SEPARATION

# Corridor Separation – Healthcare

## Section 407.2.4

Gift shops focus on retail exposure to the public. Nonetheless they are located in hospitals and typically open to corridors that fall under strict provisions for life safety. Compliance with these strict provisions using conventional opening protectives can limit market exposure.

### Fire & Life Safety Concerns

The corridor system in a hospital is designed to protect non-ambulatory patients and their attendants from the transfer of smoke from adjacent spaces. Gift shops and their associated storage offer a particular threat because of the potential fuel load created by large quantities of merchandise. The smaller the shop the lesser the threat of contents that are burning during a fire emergency, so the code requires no separation at the corridor opening of a gift shop if the square footage is minimal.

### Code Requirements

Gift shops are allowed to be open to the corridor where the total square footage does not exceed 500 square feet. (407.2.4)

To better understand the opening protective requirements let's review the corridor provisions for I-2 occupancies (hospitals).

1. The corridor wall shall be constructed as a smoke partition. (407.3)
2. Smoke partitions are not required to be fire-rated. (710.3)
3. Doors protecting openings in smoke partitions in I-2 occupancies are as follows:
  - Non-fire-rated. (407.3.1)
  - Not required to be self-closing or automatic-closing. (407.3.1)
  - Must be positive latching. (407.3.1)
  - Shall provide an effective barrier to limit the transfer of smoke. (407.3.1)
  - Must be a smoke and draft control door listed under UL 1784. (710.5.2)

# CORRIDOR SEPARATION

## Design Solutions

### CASE 1: Side Acting Accordion with Power-assisted Egress

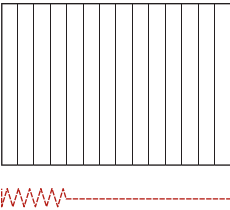

Incorporating the McKEON wide-span side acting accordion allows this space to be open for business without restricting view into the gift shop or customer access. At the command of a smoke detector the large width opening is rapidly protected and the fire and life safety corridor provisions are not compromised.

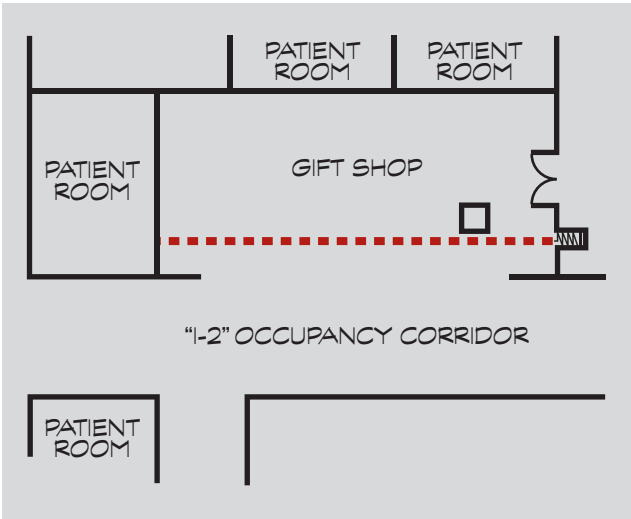

# CORRIDOR SEPARATION

## CASE 2: Vertical Acting with Complying Swing Egress Door(s)

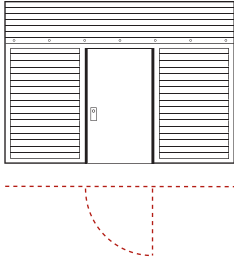

Incorporating the McKEON T5000 technology, the egress doors are completely concealed in the vertical space above, to close only in case of fire.

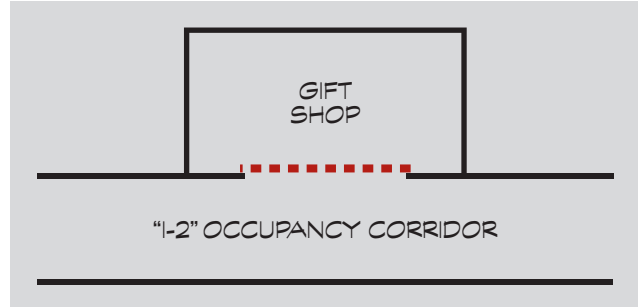

# CORRIDOR SEPARATION

## CASE 3: Vertical Coiling without Egress

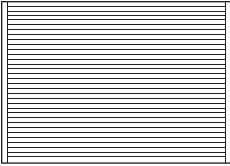

Egress is not required but a 2-hour fire rating is. This work station is left open during normal business hours. The protective assembly is easily lowered and locked after hours.

Completely automated, whether in fire or security mode, any building occupant can operate the assembly.

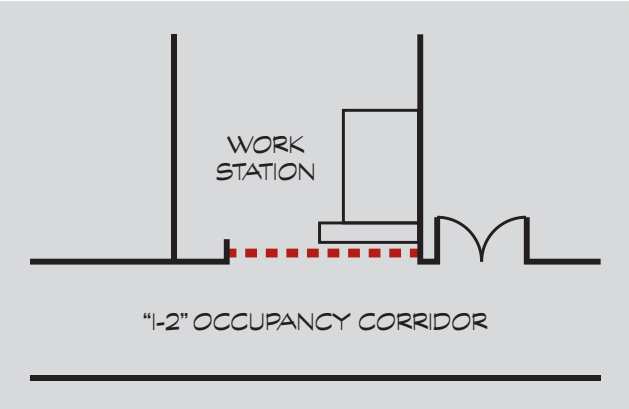

# CORRIDOR SEPARATION

## CASE 4: Vertical Acting with Complying Swing Egress Door(s)

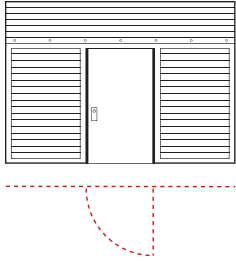

In this unique application, the McKEON T5000 technology, with integral code complying conventional egress doors, descends from the overhead space when the building goes into alarm. During normal business hours cafeteria patrons easily traverse the space from the corridor without obstruction.

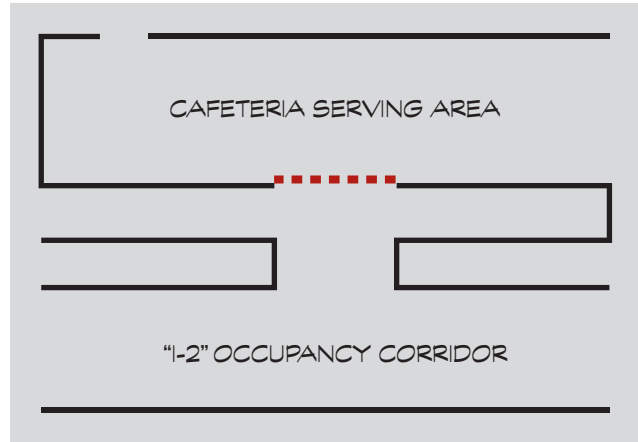

# CORRIDOR SEPARATION

## CASE 5: Side Acting Accordion with Complying Swing Egress Door

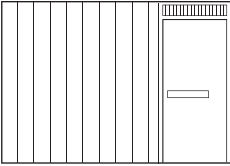

The McKEON accordion technology easily accommodates a conventional egress door.

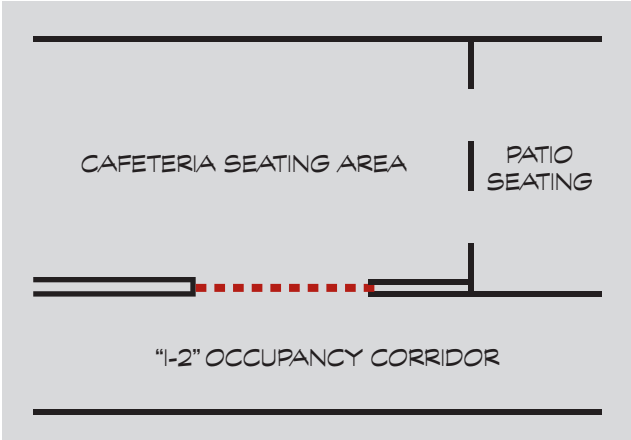



# CORRIDOR SEPARATION

## CASE 6: Vertical Acting without Egress

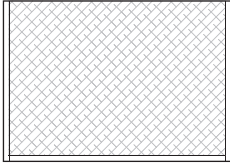

In I-2 occupancies corridor walls are required to be smoke rated only (Section 407.3). The SmokeFighter® D150 is an excellent resolve to minimal headroom space allowances. This hospital patient pharmacy is easily separated from the corridor with one of the latest technologies offered by McKEON.

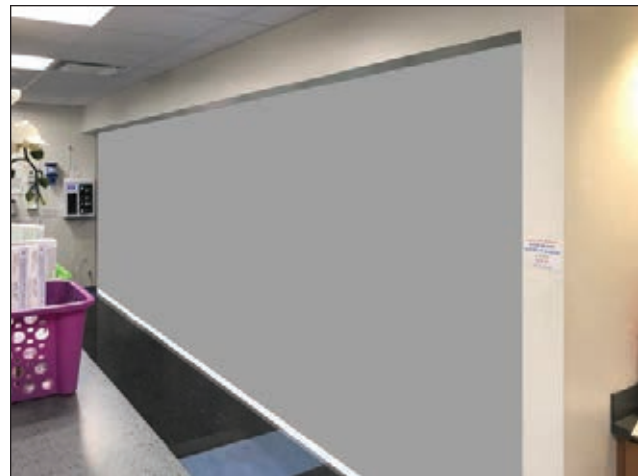
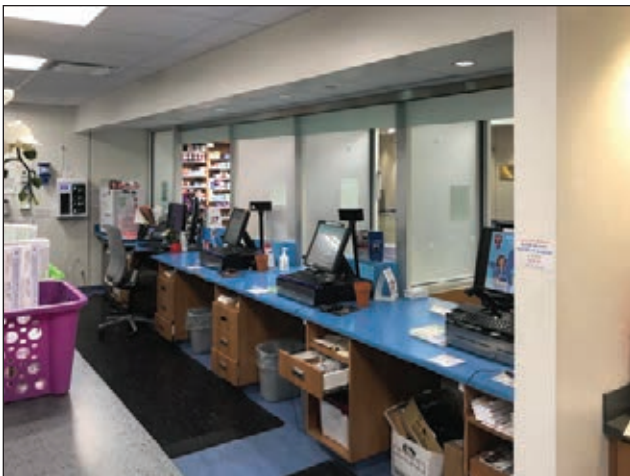
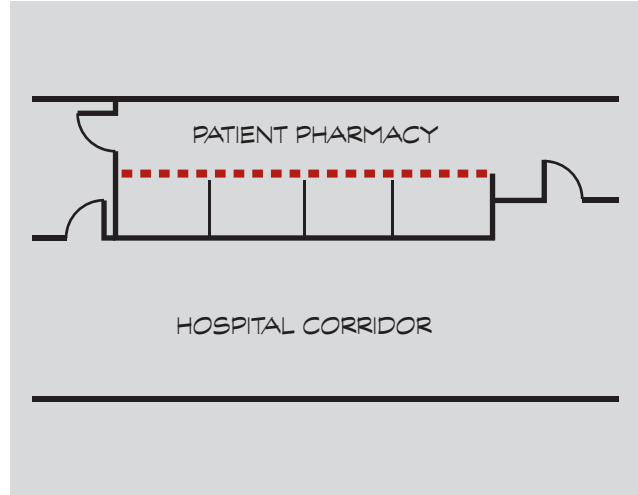

SIMULATION

# CORRIDOR SEPARATION

## CASE 7: Vertical Acting without Egress

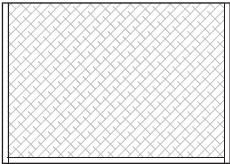

In I-2 occupancies the corridor walls are required to be smoke rated only (Section 407.3). Section 712.1.9 also instructs the design team that 2-story unprotected openings are not allowed in these same “I” occupancies. McKEON provides a unique solution to this challenge with the SmokeFighter® D150. This smoke rated curtain is

deployable and will only close when the building goes into emergency alarm. During normal business hours the entire 2-story space is free of any visual obstacles.

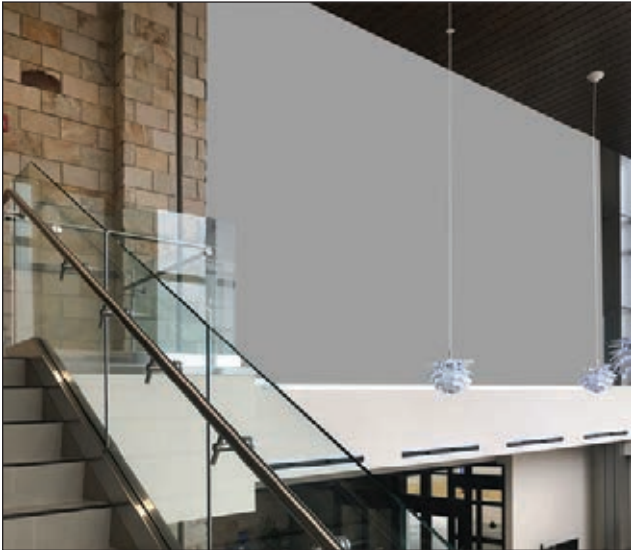
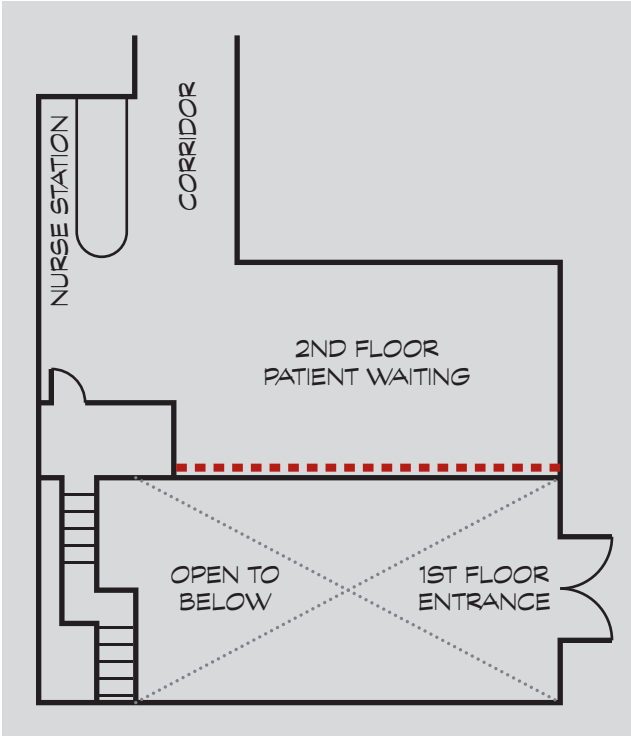

SIMULATION

# CORRIDOR SEPARATION

## CASE 8: Vertical Acting without Egress

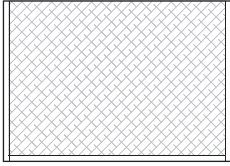

In this case study we will examine the requirements of the R-2 occupancy (congregate living facility with more than 16 occupants) pertaining to corridor rating and vertical space allowances. All corridors are required to be constructed of fire rated walls with a minimum rating of 30 minutes (1020.1). Also, these “R” occupancies cannot have unprotected 2-story openings (712.1.9, #4). These requirements can be challenging when spacious open designs are desired.

Because the opening protectives for these walls can be rated 20-minutes (716.5.3), the McKEON FireFighter® D200 is the perfect solution. Take a look, too, at CASE 9. It is right across the hall!



## CASE 9: Vertical Acting without Egress

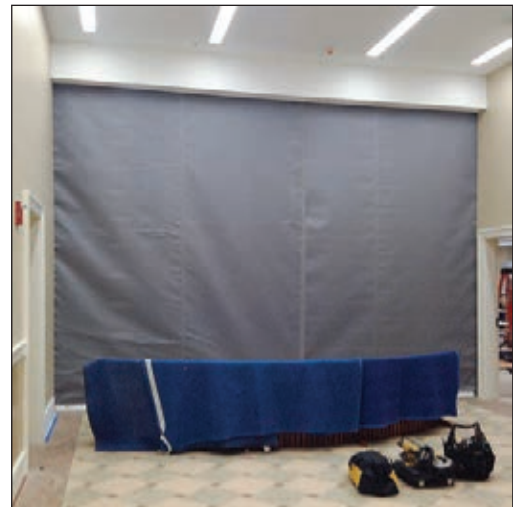
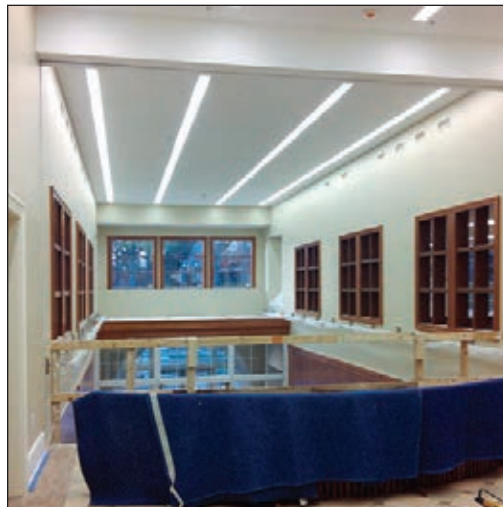
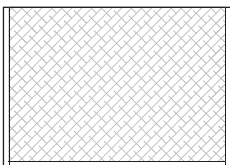





The logo for McKEON, featuring a blue square above the company name in blue, with two horizontal blue lines below it.

**McKEON®**

# 7 | Smoke Compartmentation

**Smoke Compartments – Healthcare**

**Smoke Barriers – Healthcare**

## SMOKE COMPARTMENTATION

# Smoke Compartments – Healthcare

## Section 407

The compartmentation requirements in these case studies are unique to hospital occupancies and are driven, for the most part, by means of egress provisions.

### Fire & Life Safety Concerns

The code allows patient rooms to be arranged in open suites. However, this type of arrangement supposes a low patient-to-staff ratio where the staff is directly responsible for the safety of the patients in the event of a fire. To ensure safety, small smoke compartments with short-distance egress to protected exits become critical.

### Code Requirements

1. Habitable rooms or suites in Group I-2 occupancies shall have an exit access door leading directly to a corridor. *(407.4.1)*
2. Care suites containing patient sleeping rooms shall not exceed 7,500 square feet, sprinklered areas with automatic smoke detection, 10,000 square feet. *(407.4.4.5.1)*
3. Care suites containing other than patient sleeping rooms shall not exceed 12,500 square feet, sprinklered 15,000 square feet. *(407.4.4.6.1)*
4. Any patient sleeping room, or any care suite that includes patient sleeping rooms, of more than 1,000 square feet shall have at least two exit access doors remotely located from each other. *(407.4.4.5.2)*
5. Any room or suite of rooms other than patient sleeping rooms of more than 2,500 square feet shall have at least two access doors remotely located from each other. *(407.4.4.6.2)*
6. Travel distance between any point and an exit access door in a room not located in a care suite shall not exceed 50 feet. *(407.4.2)*

# SMOKE COMPARTMENTATION

- 7. Travel distance between any point in a suite of sleeping rooms shall not exceed 100 feet, automatic smoke detection 125 feet. (407.4.4.3)
- 8. Vision panels are required in cross-corridor application of I-2 occupancies. (709.5.1)
- 9. Walls designed to create separate suites shall be construction as non-rated smoke partitions. (407.4.4.2)
- 10. Openings within smoke compartment walls that are not used to protect a vertical opening or an exit are not required to have a fire-rating but shall provide an effective barrier to limit the transfer of smoke. Also, these opening protectives do not have to be self-closing. (Section 407.3.1)

## Design Solutions

### CASE 1: Side Acting with Complying Swing Egress Door(s)

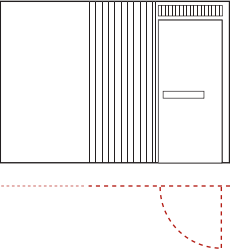

In this case study we find it difficult to maintain continuity with compartmentation when passing through corridors or other open areas with smoke partition walls. With the wide-span capabilities of the McKEON door assembly there is no compromise between building functionality and code compliance.

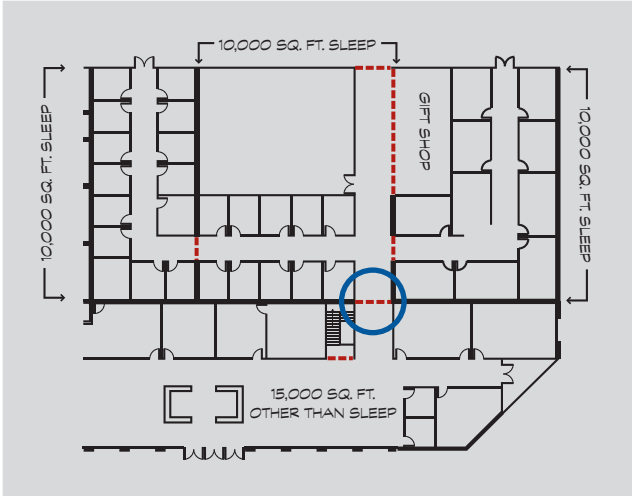



# SMOKE COMPARTMENTATION

## CASE 2: Side Acting Accordion with Complying Swing Egress Door

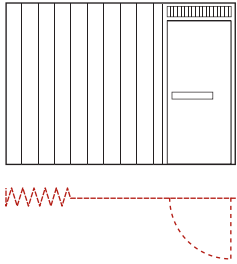

This side acting accordion offers conventional egress with a swing door attached to wide panels that provide a compact profile for less stack space.

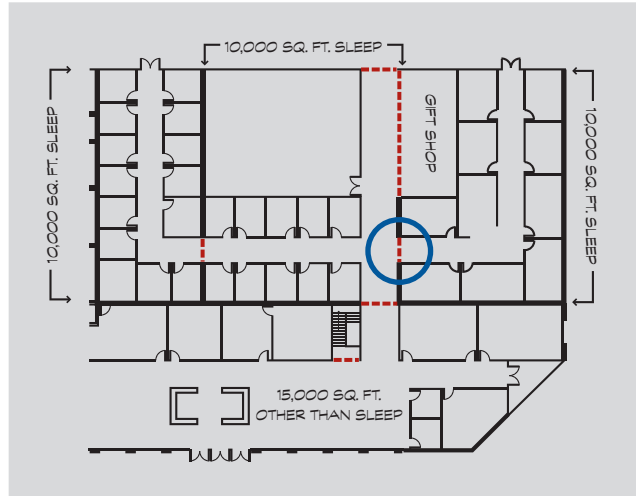

# SMOKE COMPARTMENTATION

## CASE 2: Vertical Acting without Egress

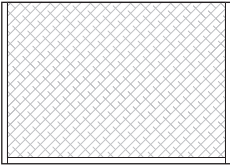

Designing care suites, particularly critical units in large hospitals, can be challenging when complying with restrictive smoke compartment provisions. The maximum area limit in care suites containing patient sleeping rooms with sprinklers and automatic smoke detection is 10,000 square feet. This case study features a critical suite that far exceeds these limits. The SmokeFighter® D150 came to the rescue and provided necessary separation where head room was limited and side room would only allow for very discreet side guides.



SIMULATION



# SMOKE COMPARTMENTATION

## Smoke Barriers – Healthcare

### Section 709

Smoke barriers divide areas of a building into separate smoke compartments. These dividing walls allow building occupants time to be evacuated or relocated to other smoke compartments. In other words, smoke barriers separate portions of buildings into areas of refuge capable of resisting the passage of smoke and fire for 1 hour. *(Section 709)*

#### Fire & Life Safety Concerns

Smoke barriers are specifically required in I-2 (hospital) occupancies due to the non-ambulatory status of the building occupants (Section 407.5). Usually these occupants require assistance and care when being evacuated or relocated during an emergency. There must be a protected area where these patients can be placed until safely evacuated from the building. Smoke barriers in Group I-2 occupancies provide this defend-in-place mechanism.

#### Code Requirements

The following five requirements designate the use of smoke barriers in Group I-2 occupancies:

1. Group I-2 occupancies are required to subdivide every story into smoke compartments with an area not more than 22,500 square feet. *(407.5)*
2. Smoke compartments are to be divided using smoke barrier walls in accordance with Section 709. *(407.5)*
3. Smoke barriers are required to subdivide every story used by patients for sleeping or treatment with an occupant load of 50 or more persons into at least two compartments. *(407.5)*
4. Travel distance in smoke compartments shall not exceed 200 feet. *(407.5)*
5. Independent egress – A means of egress shall be provided from each smoke compartment created by smoke barriers without having to return through the smoke compartment from which means of egress originated. *(Section 407.5.2)*

# SMOKE COMPARTMENTATION

In order to accommodate an opening in a smoke barrier wall the following opening protective requirements must be met:

1. Minimum fire rating of 20 minutes. (*Section 716.5.3 & Table 716.5*)
2. Vision panels. (*709.5.1*)

## Design Solutions

### CASE 1: Side Acting Accordion with Power-assisted Egress

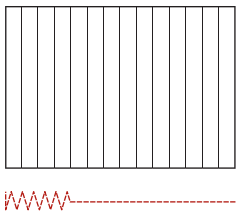

In this case study the intent is to add to an existing I-2 occupancy a 9,700 square foot Critical Care Suite. The existing building construction type is IIIA with 21,324 square feet and the desire

is to have the new suite as open as possible to the existing hospital corridor system. The placement of a smoke barrier wall at this new addition connection is a specific code requirement in order to fall within the 22,500 square foot limitation. With the use of the McKEON wide-span labeled assembly approved for egress, the opening protective requirements are met without compromising the spacious clear open ambience desired.

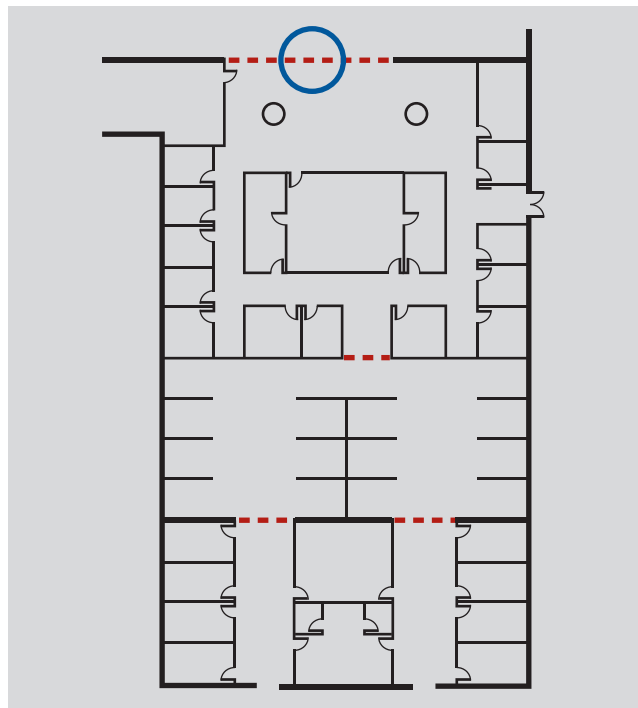

# SMOKE COMPARTMENTATION

## CASE 2: Vertical Coiling with Complying Swing Egress Door(s)

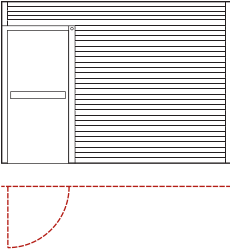

Regardless of the size of the space, smoke barriers must be maintained throughout the building. McKEON can easily protect these unusually large openings without compromising building ambience.



## CASE 3: Side Acting with Conventional Egress Door(s) & Vertical Acting with Complying Swing Egress Door(s)

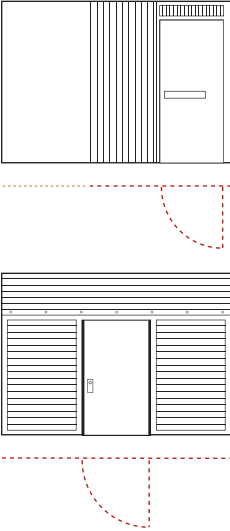

These two very different technologies converge on the inside corner of the structure to complete the smoke barrier separation creating separate refuge area compartments. Operating as dual function assemblies they are also located to separate the corridors from additional spaces.

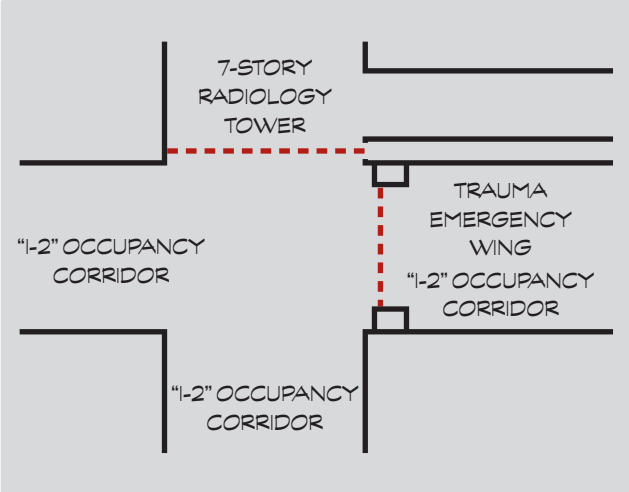





# 8 | Resilient Construction

Storm Shelters



# RESILIENT CONSTRUCTION

# Storm Shelters

## Section 423

Storm shelters can be constructed as separate detached buildings or as safe rooms within new or existing buildings. These types of structures are required to be designated hurricane shelters, tornado shelters or a combination thereof.

### Fire & Life Safety Concerns

International Building Code committee staff worked closely with the Federal Emergency Management Agency (FEMA), in particular consulting the FEMA 361 Standard, when creating a formal ICC safety standard for buildings constructed in high-wind-load areas where tornadoes and hurricanes are a prevalent threat. The ICC 500 Standard has been adopted and incorporated into Section 423 of the code to provide safe areas of refuge from these storms.

WIND ZONES IN THE UNITED STATES\*

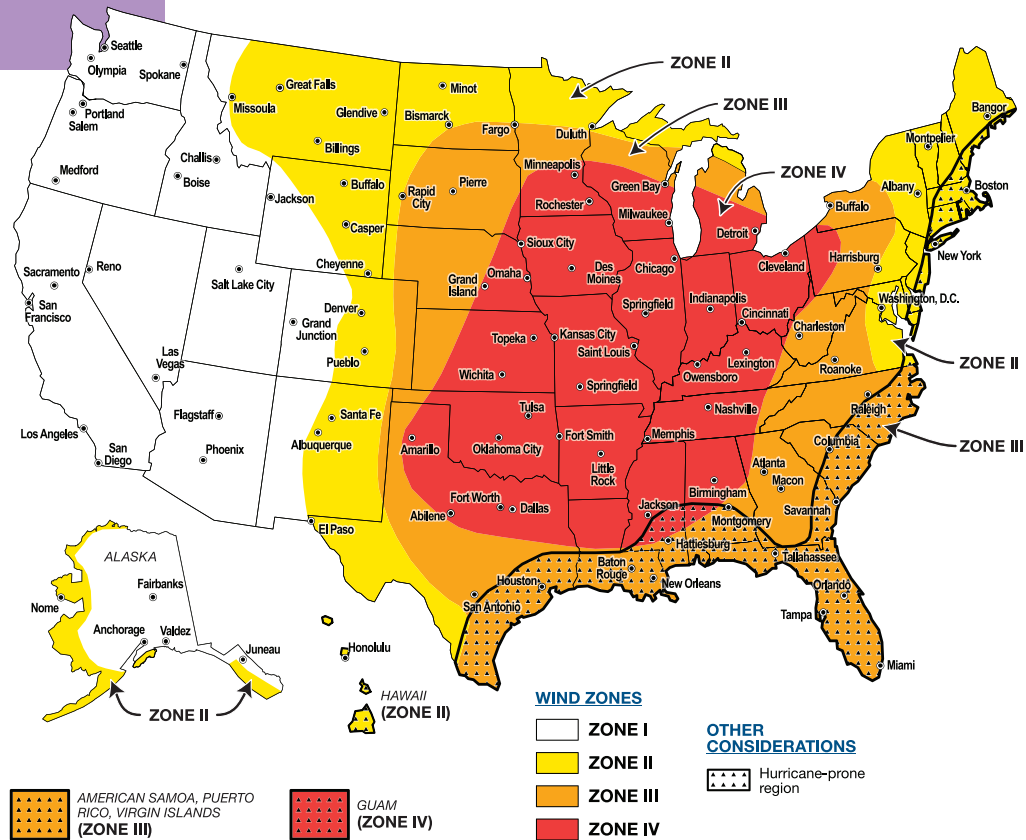

\* If you are uncertain of your location because of the level of detail and size of the map, or if you live on or near one of the delineation lines, use the highest adjacent wind zone.

# RESILIENT CONSTRUCTION

## Code Requirements

**Section 423.3 Critical emergency operations.** In areas where the shelter design wind speed for tornadoes in accordance with Figure 304.2(1) of ICC 500 is 250 MPH, 911 call stations, emergency operation center and fire, rescue, ambulance and police stations shall have a storm shelter constructed in accordance with ICC 500.

Exception: Buildings meeting the requirements for shelter design in ICC 500.

**Section 423.4 Group E occupancies.** In areas where the shelter design wind speed for tornadoes is 250 MPH in accordance with Figure 304.1(1) of ICC 500, all Group E occupancies

with an aggregate occupant load of 50 or more shall have a storm shelter constructed in accordance with ICC 500. The shelter shall be capable of housing the total occupant load of the Group E occupancy.

Exceptions:

1. Group E day care facilities
2. Group E occupancies accessory to places of religious worship
3. Buildings meeting the requirements for shelter design in ICC 500

## Design Solutions

In the case studies that follow the McKEON SafeSpace™ 500 is featured – an opening protective that complies with the stringent requirements of FEMA 361. Specifically passing the ASTM E1886 based missile impact test and withstanding wind pressures at 240 psf in accordance with ASTM E330, designers can now create large openings in exterior walls of ICC 500 compliant structures or compliant spaces within structures. Please note: When required the SafeSpace 500 can be labeled with a UL 10B 3-hour fire rating and UL 1784 smoke rating, the SafeSpace 500F model.



Missile impact test proves ability to withstand wind-borne debris from a hurricane or tornado.



The SafeSpace 500 was subjected to both a positive and a negative 255 mph wind load.

# RESILIENT CONSTRUCTION

---

## CASE 1: Vertical Coiling without Egress

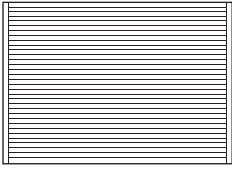

This elementary school cafeteria addition was required to comply with the FEMA 361/ICC 500 provisions. Without the SafeSpace™ 500 the three large window openings in the front of the structure would not have been possible. The cafeteria entrances would have been limited to small swing door openings and the space would have had to be artificially lit. The casual observer would not know this addition is tornado safe, it looks like a typical school multi-purpose cafeteria!



# RESILIENT CONSTRUCTION

## CASE 2: Vertical Coiling without Egress

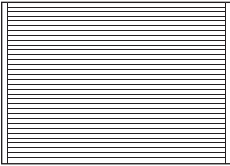

Located within the 250 MPH wind zone, a two-story summer camp facility turned the lower level into a storm shelter. With SafeSpace™ 500 technology the structure is compliant without sacrificing natural light and appearance.

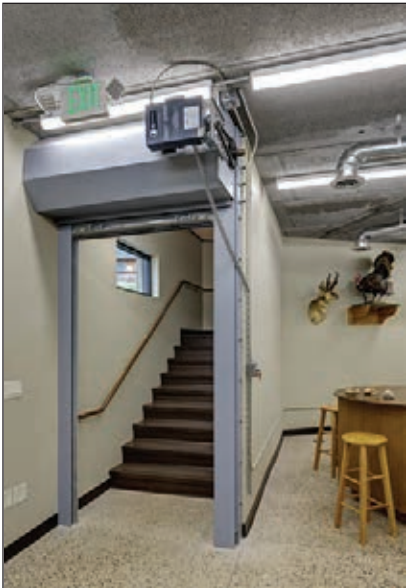

# RESILIENT CONSTRUCTION

---

## CASE 3: Vertical Coiling without Egress

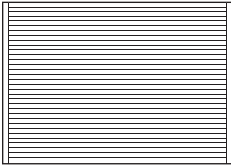

Similar to the previous cases, this beautiful library in the Ida Freeman Elementary School is also a tornado shelter. Thanks to SafeSpace™ 500 technology large windows and storefront doors let in plenty of daylight. It is easy to imagine that this area is simply a spacious, inviting area for reading and learning.







The logo for McKEON, featuring a white square above the text "McKEON" in a bold, sans-serif font, with a registered trademark symbol (®) to the right. Below the text are two horizontal white bars.

**McKEON**®

# Appendix

**Definitions**

**Resources**



# DEFINITIONS

---

## Fire Walls – Section 706

### Definition

A fire-resistance-rated wall having protected openings, which restricts the spread of fire and extends continuously from the foundation to or through the roof, with sufficient structural stability under fire conditions to allow collapse of construction on either side without collapse of the wall. (202)

### Fire Ratings: (Table 706.4)

2-hour

3-hour

4-hour

### Opening Protection: (706.8)

*Non-sprinklered buildings* – Openings shall not exceed 156 square feet and the aggregate width of openings shall not exceed 25 percent of the length of the wall.

*Sprinklered buildings* – Openings may exceed 156 square feet but the aggregate width of all openings shall not exceed 25 percent of the length of the wall.

### Design Notes

- Each portion of a building separated by one or more fire walls shall be considered a separate building. (503.1)
- Where a fire wall separates occupancies that are required to be separated by a fire barrier wall, the most restrictive requirements of each separation shall apply. (706.1)
- Regardless of the rating of the opening protective, fire walls cannot have openings that exceed 25 percent of the length of the wall. (706.8)
- Fire walls constructed as party walls shall NOT have openings. (706.1.1)

### Applications

- Exceeding area allowances (Tables 504.3, 504.4, 506.2)
- Horizontal Exits (1026)

# DEFINITIONS

---

## Fire Barriers – Section 707

### Definition

A fire-resistance-rated wall assembly of materials designed to restrict the spread of fire in which continuity is maintained. (202)

**Fire Ratings:** (Tables 716.5; 707.3.10)

1-hour

2-hour

3-hour

4-hour

### Opening Protection

*Non-sprinklered Buildings* – Openings shall be limited to a maximum aggregate width of 25 percent of the length of the wall, and the maximum area of any single opening shall not exceed 156 square feet. (707.6)

*Sprinklered Buildings* – Openings may exceed 156 square feet but must be limited to a maximum aggregate width of 25 percent of the length of the wall, unless the opening protective assembly has been tested in accordance with ASTM E119 and has a minimum fire-resistance rating not less than the fire-resistance rating of the wall. (707.6 Exceptions #1 & #3)

### Design Notes

- A fire barrier may have an opening exceed the 25 percent rule if the building is sprinklered and the opening protective assembly is tested under the provisions of ASTM E-119. As seen below, most fire-rated walls used in building design will fall under Section 707, Fire Barrier Walls.

### Applications

- Shaft Enclosures (713.4)
- Interior Exit Stairways (1023.1)
- Exit Passageways (1024.3)
- Horizontal Exits (1026.1)
- Atriums (404.6)
- Incidental Use Areas (Table 509)
- Control Areas (414.2.4)
- Separated Occupancies (Table 508.4)
- Fire Areas (Table 707.3.10)
- Enclosures for Exit Access Stairways (713.4)

# DEFINITIONS

---

## Fire Partitions – Section 708

### Definition

A vertical assembly of materials designed to restrict the spread of fire in which openings are protected. (202)

### Fire Ratings (708.3)

1-hour

1/2-hour (708.3, Exceptions #1 & #2)

### Opening Protection

Opening protectives in fire partitions shall have a minimum fire rating of 20 minutes and a maximum of 45 minutes (Table 716.5) and shall be smoke tested under UL 1784. (716.53)

### Design Notes

- Most rated corridor walls fall into this category. (708.1 and Table 1020.1)
- Typically corridor walls are not required to be rated unless the structure is non-sprinklered. (Table 1020.1)

### Applications

- Separation walls as required by Section 420.2 for Groups I-1, R-1, R-2 and R-3 (708.1, Item #1)
- Egress balconies as required by Section 1019.2 (708.1, Item #5)
- Walls separating tenant spaces in covered mall buildings as required by Section 402.4.2.1 (708.1, Item #2)
- Corridor walls as required by Section 1020.1 (708.1, Item #3)
- Elevator lobby separation as required by Section 3006.2 (708.1, Item #4)

# DEFINITIONS

---

## Smoke Barriers – Section 709

### Definition

A continuous membrane, either vertical or horizontal, such as a wall, floor, or ceiling assembly that is designed and constructed to restrict the movement of smoke. (202)

### Fire Ratings (709.3)

1-hour

### Opening Protection

Opening protectives in smoke barriers shall have a minimum 20 minute fire rating and UL 1784 smoke test rating. (Table 716.5)

### Design Notes

- Door assemblies in cross-corridor smoke barriers of I-2 Occupancies (Hospitals) shall have vision panels. (709.5.1)
- Smoke barriers constructed of minimum 0.10-inch-thick steel in I-3 Occupancies (Jails & Prisons) are not required to be 1-hour rated. (709.3)

### Applications

In I-2 Occupancies (Hospitals) smoke barriers are required to subdivide every story used by pa-

tients for sleeping or treatment. (407.5) As per the following:

- 50 or more persons / minimum 2 smoke compartments
- Each compartment cannot exceed 22,500 square feet
- Travel distance shall not exceed 200 feet to a smoke barrier door

In I-3 Occupancies (Jails & Prisons) smoke barriers are required to divide every story occupied by residents for sleeping. (408.6) As per the following:

- 50 or more persons / minimum 2 smoke compartments
- Maximum number of residents in any smoke compartment is 200
- Travel distance to any exit access component shall not exceed 150 feet
- Travel distance to any smoke barrier door shall not exceed 200 feet

# DEFINITIONS

---

## Smoke Partitions – Section 710

### Definition

A partition constructed to limit the transfer or passage of smoke. (710.4)

### Fire Ratings (710.3)

Non-rated

### Opening Protection

Door assemblies shall be UL 1784 tested and self closing by smoke detection. (710.5.2)

### Design Notes

- Corridor walls in an I-2 Occupancy (Hospital) shall be constructed as Smoke Partitions. (407.3 & 710)

### Applications

- Corridor walls of I-2 Occupancies (Hospitals) (407.3)
- Elevator Lobbies (3006.3, Item #2)
- Separation of care suites in Group I-2 Occupancies (407.4.4.2)

# International Building Code, 2018

## Means of Egress (AC8800 Series)

**1010.1.2 Door Swing.** Egress doors shall be side-hinged swinging.

**Exceptions:**

6. In other than Group H occupancies, horizontal sliding doors complying with Section 1010.1.4.3 are permitted in a means of egress.

**1010.1.4.3 Special purpose horizontal sliding accordion or folding doors.** In other than Group H occupancies, horizontal sliding doors permitted to be a component of a means of egress in accordance with Exception 6 to Section 1008.1.2 shall comply with all of the following criteria:

1. The doors shall be power operated and shall be capable of being operated manually in the event of power failure.
2. The door shall be openable by a simple method from both sides without special knowledge or effort.
3. The force required to operate the door shall not exceed 30 pounds (133 N) to set the door in motion and 15 pounds (67 N) to close the door or open it to the minimum required width.
4. The door shall be openable with a force not to exceed 15 pounds (67 N) when a force of 250

pounds (1100 N) is applied perpendicular to the door adjacent to the operating device.

5. The door assembly shall comply with the applicable fire protection rating and, where rated, shall be self-closing or automatic closing by smoke detection in accordance with Section 716.5.9.3 and shall be installed in accordance with NFPA 80 and shall comply with Section 716.
6. The door assembly shall have an integrated standby power supply.
7. The door assembly power supply shall be electrically supervised.
8. The door shall open to the minimum required width within 10 seconds after activation of the operating device.

# NFPA 101 Life Safety Code, 2018

## Means of Egress

### 7.2.1.4 Swing and Force to Open

**7.2.1.4.1.4a, b, c** Special-purpose horizontally sliding accordion or folding door assemblies complying with 7.2.1.14 shall be permitted.

#### **7.2.1.14 Special-Purpose Horizontally Sliding Accordion or Folding Door Assemblies.**

Special-purpose horizontally sliding accordion or folding door assemblies shall be permitted in a means of egress, provided that the following criteria are met:

1. The door leaf is readily operable from either side without special knowledge or effort.
2. The force that, when applied to the operating device in the direction of egress, is required to operate the door leaf is not more than 15 lbf (67 N).
3. The force required to operate the door leaf in

the direction of door travel is not more than 30 lbf (133 N) to set the leaf in motion and is not more than 15 lbf (67 N) to close the leaf or open it to the minimum required width.

4. The door leaf is operable using a force of not more than 50 lbf (222 N) when a force of 250 lbf (1100 N) is applied perpendicularly to the leaf adjacent to the operating device, unless the door is an existing special-purpose horizontally sliding accordion or folding exit access door assembly serving an area with an occupant load of fewer than 50.
5. The door assembly complies with the fire protection rating, if required, and, where rated, is self-closing or automatic-closing by means of smoke detection in accordance with 7.2.1.8 and is installed in accordance with *NFPA 80, Standard for Fire Doors and Fire Windows*.

## INTERTEK Code Compliance Research Report CCRR 1086

For access to this report:

- Download from the Intertek website: [intertek.com/building/ccrr/](http://intertek.com/building/ccrr/)
- Download from the McKEON website: [mckeondoor.com](http://mckeondoor.com)

# International Building Code, 2021

## 202 Definitions, 716 Opening Protectives, Referenced Standards

The development and final vote of the following code sections have been completed and will be published in the 2021 edition of the IBC:

### Section 202 Definitions

**FIRE PROTECTIVE CURTAIN ASSEMBLY.** An assembly consisting of a fabric curtain, bottom bar, guides, coil, operating and closing system.

### Section 716 Opening Protectives

**716.4 Fire protective curtain assembly.** Approved fire protective curtain assemblies shall be constructed of any materials or assembly of component materials tested without hose stream in accordance with UL 10D, and shall comply with Sections 716.4.1 through 716.4.3.

**716.4.1 Label.** Fire protective curtain assemblies used as opening protectives in fire rated walls and smoke partitions shall be labeled in accordance with 716.2.9.

**716.4.2 Smoke and draft control.** Fire protective curtain assemblies used to protect openings where smoke and draft control assemblies are required shall comply with Section 716.2.1.4.

**716.4.3 Installation.** Fire protective curtain assemblies shall be installed in accordance with NFPA 80.

### Referenced Standards

**UL 10D-17,** Standard for Fire Tests of Fire Protective Curtain Assemblies (shown below)

### INTRODUCTION

#### 1 Scope

1.1 These requirements cover the evaluation of fire-protective curtain assemblies intended to provide supplemental, passive fire protection as part of an engineered fire protection system. Fire-protective curtain assemblies are horizontally or vertically oriented. Horizontally or vertically oriented fire-protective curtain assemblies provide nonstructural separation only, and are not intended to be substituted for structural hourly rated partitions or opening protectives that have been tested for fire endurance and hose stream performance.



## RESOURCES

# McKEON Curtain Systems Egress Feature

All SmokeFire® and FireFighter® models that incorporate the egress feature are intended for conditional use in low occupant load applications. The smoke or smoke and fire rated swinging curtain door complies with all exit door requirements in IBC, Chapter 10, Means of Egress, with the exception of the 32/80 rule. In simple terms, a required exit door must open a minimum of 32 inches in width and 80 inches high. Consult the following page for details regarding opening widths and heights.

### Code Requirements

**Section 1010.1.2 Door Swing.** Egress doors shall be of the pivoted or side-hinged swinging type.

The egress door of both SmokeFighter and FireFighter includes a hinged bottom bar located at 90 degrees to the fabric so that when the fabric is pushed to the open position both bottom bar and fabric easily swing providing egress to allow building occupants to exit.



# RESOURCES

**Section 1010.1.1 Size of doors.** The required capacity of each door opening shall be sufficient for the occupant load thereof and shall provide a minimum clear opening width of 32 inches (813 mm) ... The minimum clear opening height of doors shall be not less than 80 inches (2032 mm).

The following photo/dimensions and table will help you determine compliance with this code requirement.

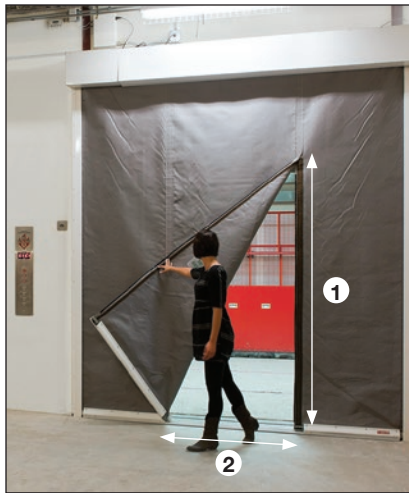

Product	Opening Height from Floor	Opening (swing) Force (LBF)	Opening Dimensions
Smoke/Smoke & Fire Curtains	18"	Less than 1/2 lbf	36"
Smoke/Smoke & Fire Curtains	36"	Less than 1/2 lbf	22 1/2"
Smoke/Smoke & Fire Curtains	54"	Less than 1/2 lbf	20"
Smoke/Smoke & Fire Curtains	72"	Less than 1/2 lbf	12"
Smoke/Smoke & Fire Curtains	84"	Less than 1/2 lbf	6"

**Section 1010.1.3 Door opening force** ... the door latch shall release when subjected to a 15-pound (67 N) force. The door shall be set in motion when subjected to a 30-pound (133 N) force. The door shall swing to a full-open position when subjected to a 15-pound (67 N) force.

The following test data confirms that the egress feature of both SmokeFighter and FireFighter complies with these requirements.



### Flexible Fabric Door Compliance Test

<b>Force A (LBF)</b> Opening force to set egress in motion, hook & loop ripped open	26
<b>Force B (LBF)</b> Swing force to swing egress door to fully open position	0.5
<b>Force C (LBF)</b> Force required to hold egress door in the fully open 90 position	4
<b>Height</b>	34"

#### ADA Notes:

- Doors designated as fire doors must have the minimum opening force allowed by the local authority.
- Interior accessible doors should require no more than 5 lbs. of force to open.
- Threshold cannot be higher than 1/2 inch at accessible doors.





44 Sawgrass Drive  
Bellport, NY 11713  
Phone: 800-266-9392  
Fax: 631-803-3030  
Email: [info@mckeondoor.com](mailto:info@mckeondoor.com)  
[www.McKeonDoor.com](http://www.McKeonDoor.com)

